

COMMERCIAL

BROCHURE

TOTO

Life Anew

WALL-HUNG URINAL WITH INTEGRATED ECOPOWER® FLUSH VALVE

TOTO's new **Wall-Hung Urinal with Integrated ECOPOWER® Flush Valve** combines style, convenience, and planet friendliness. This new model features an integrated, hydroelectric flush valve, ultra-high efficiency 0.125 GPF, a rimless design, and CEFIONTECT® glaze for maximum cleanliness and design. An ADA compliant product, the new wall-hung urinal also features the latest in sensor technologies, upgrading any public restroom's hygiene and environmental sustainability.





Products shown:

Wall-Hung Urinal with Integrated ECOPOWER® Flush Valve;
Axiom® Wall-Mount Faucet; Touchless Soap Dispenser - Square;
Rectangle Undercounter Lavatory; Clean Dry High Speed Hand Dryer

NEW

**WALL-HUNG URINAL WITH INTEGRATED
AUTOMATIC FLUSH VALVE AND BACK INLET**

0.125 GPF

UE906UVG



- ▶ Compact urinal with integrated flush valve and 1/2" supply connection
- ▶ Ultra high-efficiency - 0.125 GPF (0.473 LPF)
- ▶ Self-powered hydroelectric flush valve system
- ▶ CEFIONTECT® ceramic glaze minimizes waste from sticking to porous ceramic surfaces
- ▶ Rimless design with spreader flushing system
- ▶ Protects trap seal with a maintenance flush every 12 hour period
- ▶ Photoelectric sensor detection to prevent ghost flushing
- ▶ ADA compliant
- ▶ Contributes to earning credits in LEED®
- ▶ CalGreen compliant

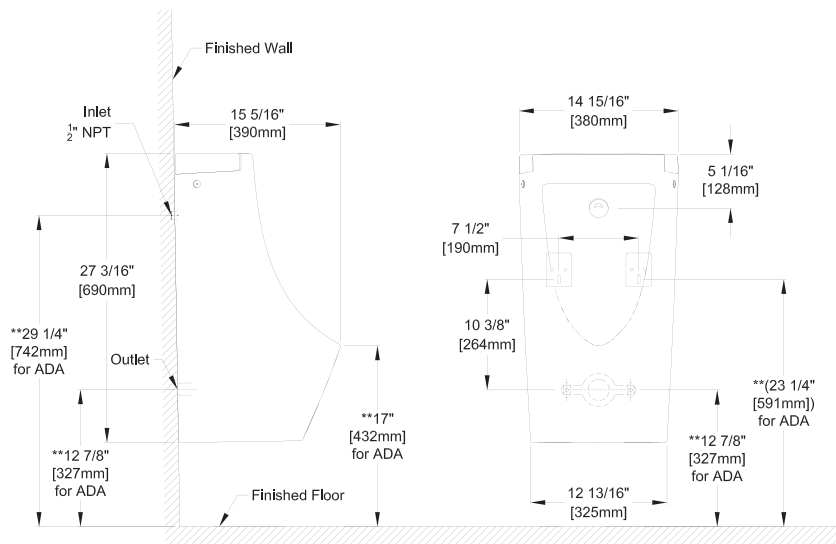

**Recommended for ADA height installation for 17" floor to rim.

**AVAILABLE
COLOR**

#01
Cotton

For more information on dimensions please refer to product spec sheet.

COMMERCIAL URINALS OVERVIEW

**WASHOUT ULTRA
HIGH-EFFICIENCY URINAL**
0.125 GPF
UT445U



**WASHOUT ULTRA
HIGH-EFFICIENCY URINAL**
0.125 GPF
UT445UV



**WASHOUT ULTRA
HIGH-EFFICIENCY URINAL**
0.125 GPF
UT105U(G)



**WASHOUT ULTRA
HIGH-EFFICIENCY URINAL**
0.125 GPF
UT105UV(G)



- ▶ Full size urinal with integral trap
- ▶ Washout flush action with 3/4" top spud inlet
- ▶ 0.125 gpf
- ▶ Complete with low profile dome strainer
- ▶ For compatible flush valves, see page 15

- ▶ Full size urinal with concealed integral trap
- ▶ Washout flush action with 3/4" back spud inlet
- ▶ 0.125 gpf
- ▶ Complete with low profile dome strainer
- ▶ For compatible flush valves, see page 15

- ▶ Compact urinal with integral trap
- ▶ Washout flush action with 3/4" top spud inlet
- ▶ 0.125 GPF
- ▶ Complete with low profile dome strainer
- ▶ Optional CEFIONTECT® glaze prevents debris from sticking to ceramic surfaces, making them easier to clean
- ▶ For compatible flush valves, see page 15

- ▶ Compact urinal with concealed integral trap
- ▶ Washout flush action with 3/4" back spud inlet
- ▶ 0.125 GPF
- ▶ Complete with low profile dome strainer
- ▶ Optional CEFIONTECT glaze prevents debris from sticking to ceramic surfaces, making them easier to clean
- ▶ For compatible flush valves, see page 15

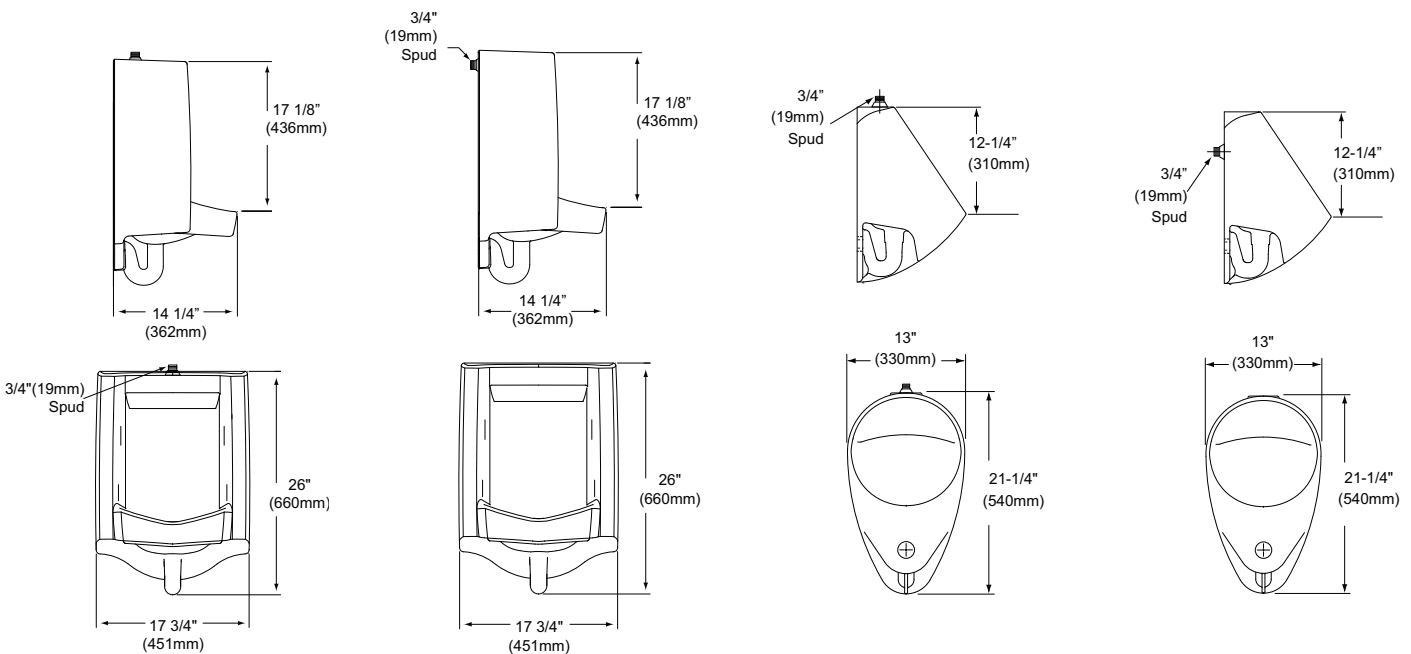

For more information on dimensions please refer to product spec sheet.

**AVAILABLE
COLOR**



COMMERCIAL URINALS

OVERVIEW

WASHOUT HIGH-EFFICIENCY URINAL
0.5 GPF
UT447E

WASHOUT HIGH-EFFICIENCY URINAL
0.5 GPF
UT447EV

WASHOUT HIGH-EFFICIENCY URINAL
0.5 GPF
UT104E

WASHOUT HIGH-EFFICIENCY URINAL
0.5 GPF
UT104EV



- ▶ Full size urinal with concealed integral trap
- ▶ Washout flush action with 3/4" top spud inlet
- ▶ 0.5 gpf
- ▶ For compatible flush valves, see page 15

- ▶ Full size urinal with concealed integral trap
- ▶ Washout flush action with 3/4" back spud inlet
- ▶ 0.5 gpf
- ▶ For compatible flush valves, see page 15

- ▶ Compact urinal with concealed integral trap
- ▶ Washout flush action with 3/4" top spud inlet
- ▶ 0.5 gpf
- ▶ For compatible flush valves, see page 15

- ▶ Compact urinal with concealed integral trap
- ▶ Washout flush action with 3/4" back spud inlet
- ▶ 0.5 gpf
- ▶ For compatible flush valves, see page 15

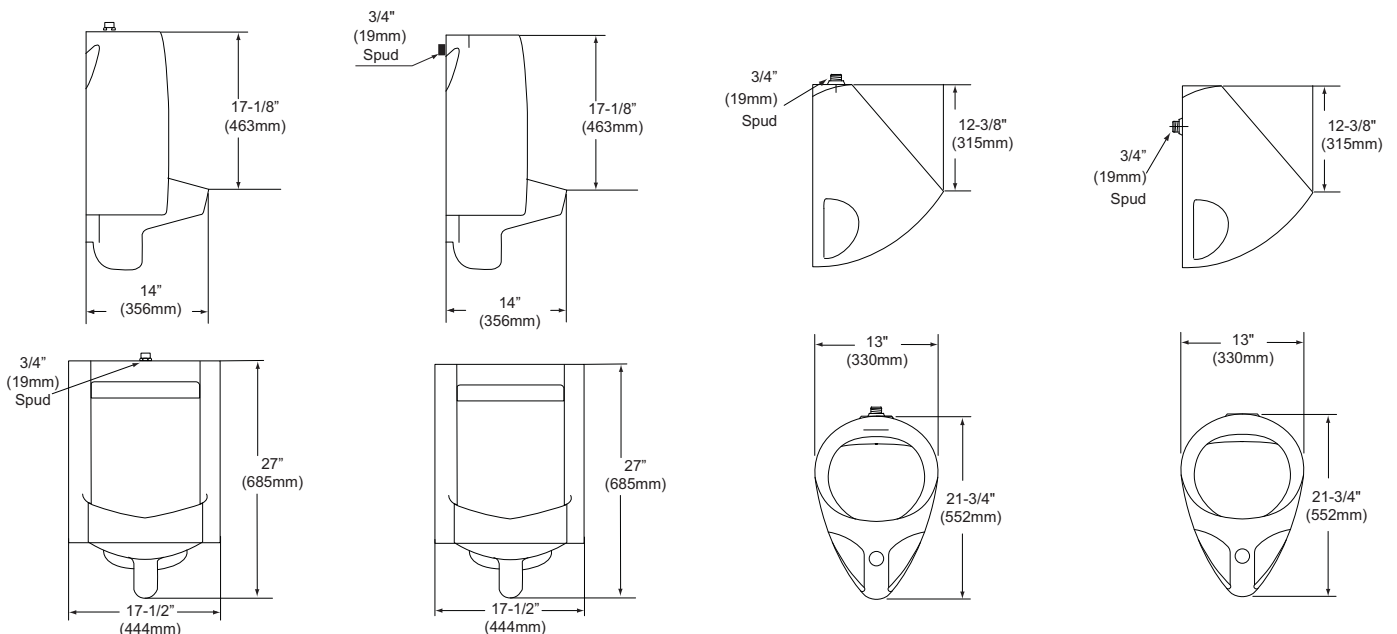

AVAILABLE
COLOR



For more information on dimensions please refer to product spec sheet.

THE POWER OF RECLAIMED WATER

Innovation & Technology Highlights

COMMITTED TO SAVING WATER DROP BY DROP.



Water conservation extends far beyond the amount we use. Reclaimed water aims to reduce the amount of potable water used in our toilet systems. Recycling water already used for toilets conserves our precious, finite sources of fresh water.

COMMERCIAL TOILETS OVERVIEW

**COMMERCIAL FLUSHOMETER
FLOOR-MOUNTED TOILET**
1.0/1.28 GPF
CT725CU(G)X



- ▶ TORNADO FLUSH® is a sustainable, high-performance system that effectively removes waste, utilizing 360° of cleaning power to scour the bowl and rim
- ▶ Floor-mounted
- ▶ Elongated front bowl
- ▶ Optional CEFIONTECT® ceramic glaze minimizes waste from sticking to porous ceramic surfaces
- ▶ Clear glazed trapway coating
- ▶ 10"-12" rough-in
- ▶ Designed for reclaimed water use
- ▶ Available in cotton #01 only

**COMMERCIAL FLUSHOMETER
ADA FLOOR-MOUNTED TOILET**
1.0/1.28 GPF
CT725CUF(G)X



- ▶ TORNADO FLUSH is a sustainable, high-performance system that effectively removes waste, utilizing 360° of cleaning power to scour the bowl and rim
- ▶ Floor-mounted
- ▶ ADA compliant
- ▶ UNIVERSAL HEIGHT
- ▶ Elongated front bowl
- ▶ Optional CEFIONTECT ceramic glaze minimizes waste from sticking to porous ceramic surfaces
- ▶ Clear glazed trapway coating
- ▶ 10"-12" rough-in
- ▶ Designed for reclaimed water use
- ▶ Available in cotton #01 only

**COMMERCIAL FLUSHOMETER
TOP SPUD WALL-HUNG TOILET**
1.0/1.28 GPF
CT728CU(G)X



- ▶ TORNADO FLUSH is a sustainable, high-performance system that effectively removes waste, utilizing 360° of cleaning power to scour the bowl and rim.
- ▶ Wall-mounted
- ▶ Elongated front bowl
- ▶ Optional CEFIONTECT ceramic glaze minimizes waste from sticking to porous ceramic surfaces
- ▶ Clear glazed trapway coating
- ▶ Designed for reclaimed water use
- ▶ Maximum static load rating of 1000 lbs when used with appropriate wall carrier
- ▶ For compatible flush valves, see page 23
- ▶ Available in cotton #01 only

12" rough-in dimensions

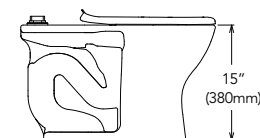
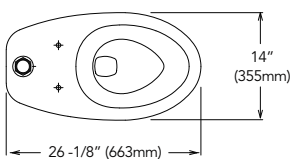

12" rough-in dimensions

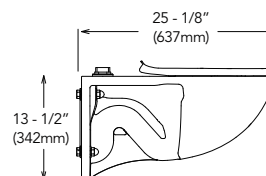
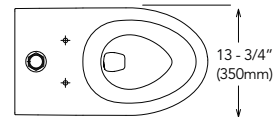
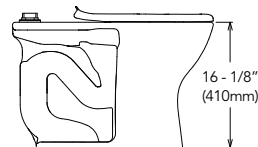
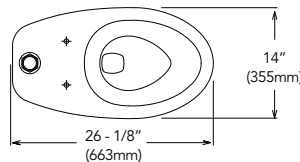

**AVAILABLE
COLOR**



For more information on dimensions please refer to product spec sheet.

TOILET FLUSH VALVES

OVERVIEW

ECOPOWER EXPOSED TOILET FLUSH VALVE

TET1UBX - 1.0 GPF
TET1LBX - 1.28 GPF



- ▶ Designed with robust materials necessary for reclaimed water use
- ▶ Self-powered hydroelectric flush valve system
- ▶ No minimum daily usage requirement
- ▶ Durable chrome plated body with tamperproof screws and solid bronze valve body
- ▶ Self-cleaning piston valve with 360° filter screen
- ▶ Neutral rough-in and adjustable tail piece connection
- ▶ True mechanical flush override
- ▶ Smart sensor with self-adjusting detection range
- ▶ 6 second detection time to prevent ghost flushing
- ▶ For toilet with 1-1/2" top spud inlet
- ▶ Exposed flush valve with 1" angle stop and 1-1/2" vacuum breaker set
- ▶ Contributes to earning credits in LEED®
- ▶ Protects trap seal with a maintenance flush if not used in a 24 hr period
- ▶ ADA compliant

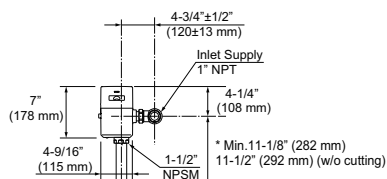

AVAILABLE
FINISH



For more information on dimensions please refer to product spec sheet.

COMMERCIAL URINALS OVERVIEW

WASHOUT HIGH-EFFICIENCY URINAL
0.5 GPF
UT447EX



- ▶ Designed for reclaimed water
- ▶ Full size urinal with concealed integral trap
- ▶ Washout flush action with 3/4" top spud inlet
- ▶ For compatible flush valves, see page 25
- ▶ ADA compliant

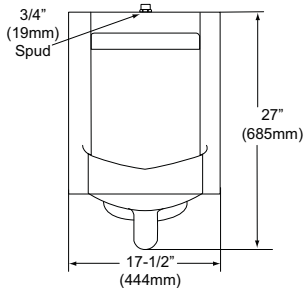
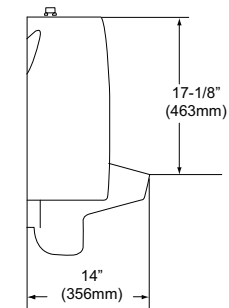

WASHOUT ULTRA HIGH-EFFICIENCY URINAL
0.125 GPF
UT445UX



- ▶ Designed for reclaimed water
- ▶ Full size urinal with integral trap
- ▶ Washout flush action with 3/4" top spud inlet
- ▶ Complete with low profile dome strainer
- ▶ For compatible flush valves, see page 25
- ▶ ADA compliant

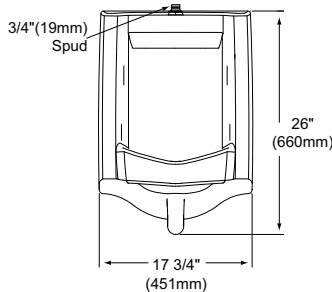
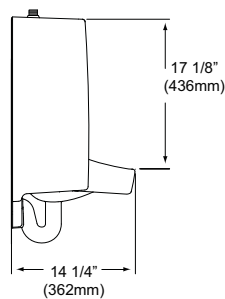

WASHOUT HIGH-EFFICIENCY URINAL
0.5 GPF
UT104EX



- ▶ Designed for reclaimed water
- ▶ Compact urinal with concealed integral trap
- ▶ Washout flush action with 3/4" top spud inlet
- ▶ For compatible flush valves, see page 25
- ▶ ADA compliant

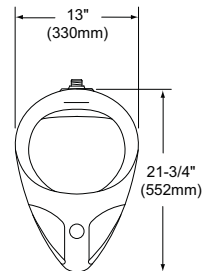
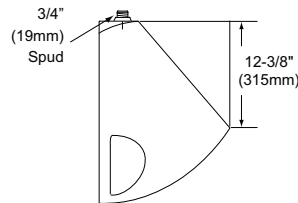

WASHOUT ULTRA HIGH-EFFICIENCY URINAL
0.125 GPF
UT105U(G)X



- ▶ Designed for reclaimed water
- ▶ Compact urinal with integral trap
- ▶ Washout flush action with 3/4" top spud inlet
- ▶ Complete with low profile dome strainer
- ▶ Optional CEFIONTECT® glaze prevents debris from sticking to ceramic surfaces, making them easier to clean
- ▶ For compatible flush valves, see page 25
- ▶ ADA compliant

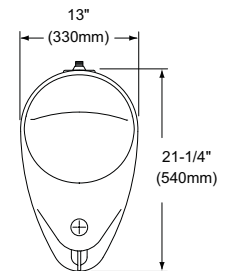
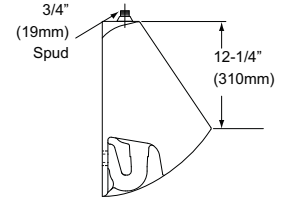

**AVAILABLE
COLOR**



For more information on dimensions please refer to product spec sheet.

URINAL FLUSH VALVES

OVERVIEW

ECOPOWER EXPOSED URINAL FLUSH VALVE

TEU1UAX - 0.125 GPF

TEU1LAX - 0.5 GPF



- ▶ Designed with robust materials necessary for reclaimed water
- ▶ Self-powered hydroelectric flush valve system
- ▶ No minimum daily usage requirement
- ▶ Durable chrome plated body with tamper-proof screws and solid bronze valve body with EPD coating
- ▶ Self-cleaning piston valve with 360° filter screen
- ▶ Neutral rough-in and adjustable tail piece connection
- ▶ True mechanical flush override
- ▶ Smart sensor with self-adjusting detection range
- ▶ 6-second detection time to prevent ghost flushing
- ▶ ADA compliant

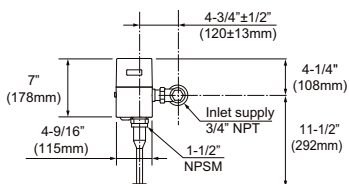

AVAILABLE
FINISH



For more information on dimensions please refer to product spec sheet.

The security of TOUCHLESS

A new world. A better way to clean.





COMMERCIAL TOUCHLESS RESTROOMS



Offer a Clean, Comfortable Experience and Help Protect the Environment

Today more than ever before, patrons want to decrease public restroom touchpoints as much as possible. From no-touch faucets and flush valves to automatic soap dispensers and hand dryers, TOTO's hands-free products give patrons confidence that their restroom experience will be clean, comfortable, and convenient. In addition, TOTO's stylish, high-performance sensor products save energy, water, time, and money without sacrificing an ounce of performance. Facilities around the globe choose TOTO's innovative sensor products for their public restrooms to offer patrons a clean, comfortable experience and help protect the environment.

www.totousa.com/touchless



SCAN CODE
TO PLAY VIDEO





TOILET FLUSH VALVES OVERVIEW

ECOPOWER® CONCEALED TOILET FLUSH VALVE

- TET2UB - 1.0 GPF
- TET2LB - 1.28 GPF
- TET2GB - 1.6 GPF



- ▶ Self-powered hydroelectric flush valve system
- ▶ No minimum daily usage requirement
- ▶ Heavy duty 14" x 12" stainless steel cover plate with satin finish and solid bronze valve body
- ▶ Self-cleaning piston valve with 360° filter screen
- ▶ Neutral rough-in and adjustable tail piece connection
- ▶ Manual flush override
- ▶ Smart sensor with self-adjusting detection range
- ▶ 6 second detection time to prevent ghost flushing
- ▶ Concealed flush valve with 1" angle stop and 1-1/2" vacuum breaker set
- ▶ *Contributes to earning credits in LEED®
- ▶ Protects trap seal with a maintenance flush if not used in a 24 hr period
- ▶ ADA compliant
- ▶ Available in Stainless Steel (#SS) only

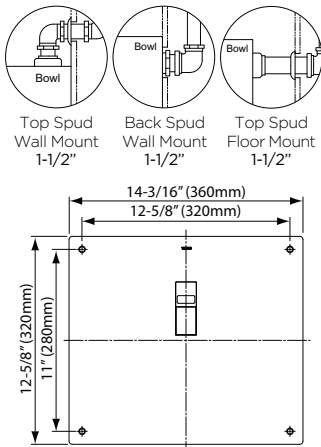

ECOPOWER CONCEALED TOILET FLUSH VALVE

- TET3UB- 1.0 GPF
- TET3LB - 1.28 GPF
- TET3GB - 1.6 GPF



- ▶ Self-powered hydroelectric flush valve system
- ▶ No minimum daily usage requirement
- ▶ 4" x 4" stainless steel cover plate with brushed satin finish and solid bronze valve body
- ▶ Self-cleaning piston valve with 360° filter screen
- ▶ Neutral rough-in and adjustable tail piece connection
- ▶ Manual flush override
- ▶ Smart sensor with self-adjusting detection range
- ▶ 6 second detection time to prevent ghost flushing
- ▶ Concealed flush valve with 1" angle stop and 1-1/2" vacuum breaker set
- ▶ *Contributes to earning credits in LEED
- ▶ Protects trap seal with a maintenance flush if not used in a 24 hr period
- ▶ ADA compliant
- ▶ Available in Stainless Steel (#SS) only

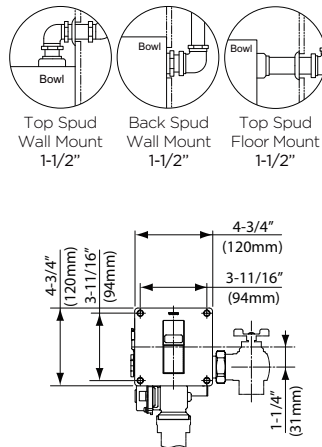

ECOPOWER EXPOSED TOILET FLUSH VALVE

- TET1UB - 1.0 GPF
- TET1LB - 1.28 GPF
- TET1GB - 1.6 GPF



- ▶ Self-powered hydroelectric flush valve system
- ▶ No minimum daily usage requirement
- ▶ Durable chrome plated body with tamper proof screws and solid bronze valve body
- ▶ Self-cleaning piston valve with 360° filter screen
- ▶ Neutral rough-in and adjustable tail piece connection
- ▶ True mechanical flush override
- ▶ Smart sensor with self-adjusting detection range
- ▶ 6 second detection time to prevent ghost flushing
- ▶ For toilet with 1-1/2" top spud inlet
- ▶ Exposed flush valve with 1" angle stop and 1-1/2" vacuum breaker set
- ▶ *Contributes to earning credits in LEED
- ▶ Protects trap seal with a maintenance flush if not used in a 24 hr period
- ▶ ADA compliant
- ▶ Available in Polished Chrome (#CP) only

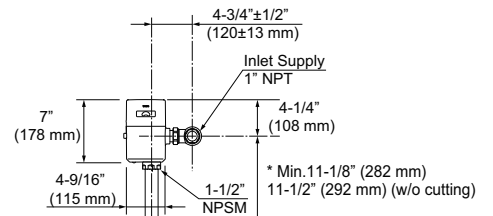

*Only applies to 1.28 & 1.0 GPF toilet flush valves.

For more information on dimensions please refer to product spec sheet.

TOILET FLUSH VALVES OVERVIEW

ECOPOWER EXPOSED 24" VACUUM BREAKER TOILET FLUSH VALVE

TET6UB - 1.0 GPF
TET6LB - 1.28 GPF
TET6GB - 1.6 GPF



- ▶ Self-powered hydroelectric flush valve system
- ▶ No minimum daily usage requirement
- ▶ Durable chrome plated body with tamper-proof screws and solid bronze valve body
- ▶ Self-cleaning piston valve with 360° filter screen
- ▶ Neutral rough-in and adjustable tail piece connection
- ▶ True mechanical flush override
- ▶ Smart sensor with self-adjusting detection range
- ▶ 6-second detection time to prevent ghost flushing
- ▶ For toilet with 1-1/2" top spud inlet using 24" vacuum breaker bar
- ▶ *Contributes to earning credits in LEED
- ▶ ADA compliant
- ▶ Available in Polished Chrome (#CP) only

MANUAL TOILET FLUSH VALVE

TMT1LN32 - 1.28 GPF
TMT1NNC-32 - 1.6 GPF



- ▶ Manual operated, non-hold open, toilet flush valve complete with 1" angle stop and 1-1/2" vacuum breaker set
- ▶ Piston valve action with 1.28/1.6 GPF
- ▶ Left/right rough-in
- ▶ Top spud exposed
- ▶ ADA compliant
- ▶ Available in Polished Chrome (#CP) only

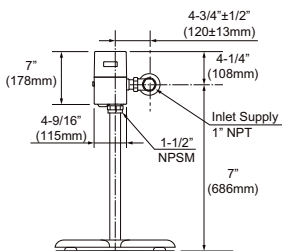

For more information on dimensions please refer to product spec sheet.

AVAILABLE FINISHES



#SS
Stainless Steel



#CP
Polished
Chrome

*Only applies to 1.28 & 1.0 GPF toilet flush valves.



URINAL FLUSH VALVES OVERVIEW

ECOPOWER CONCEALED URINAL FLUSH VALVE
 TEU2UAR - 0.125 GPF
 TEU2LAR - 0.5 GPF



ECOPOWER CONCEALED URINAL FLUSH VALVE
 TEU3UAR - 0.125 GPF
 TEU3LAR - 0.5 GPF



ECOPOWER EXPOSED URINAL FLUSH VALVE
 TEU1UAR - 0.125 GPF
 TEU1LAR - 0.5 GPF
 TEU1GAR - 1.0 GPF



MANUAL URINAL FLUSH VALVE
 TMU1LN12 - 0.5 GPF
 TMU1NNC-12 - 1.0 GPF



- ▶ Self-powered hydroelectric flush valve system
- ▶ No minimum daily usage requirement
- ▶ 14" x 12" stainless steel cover plate with solid bronze valve body
- ▶ Neutral rough-in and adjustable tail piece connection
- ▶ Self-cleaning piston valve with 360° filter screen†
- ▶ Manual flush override
- ▶ Smart sensor with self-adjusting detection range
- ▶ 6-second detection time to prevent ghost flushing
- ▶ ADA compliant
- ▶ Available in Stainless Steel (#SS) only

- ▶ Self-powered hydroelectric flush valve system
- ▶ No minimum daily usage requirement
- ▶ 4" x 4" brushed stainless steel cover plate with solid bronze valve body
- ▶ Neutral rough-in and adjustable tail piece connection
- ▶ Self-cleaning piston valve with 360° filter screen†
- ▶ Manual flush override
- ▶ Smart sensor with self-adjusting detection range
- ▶ 6-second detection time to prevent ghost flushing
- ▶ ADA compliant
- ▶ Available in Stainless Steel (#SS) only

- ▶ Self-powered hydroelectric flush valve system
- ▶ No minimum daily usage requirement
- ▶ Durable chrome plated body with tamper-proof screws and solid bronze valve body
- ▶ Self-cleaning piston valve with 360° filter screen†
- ▶ Neutral rough-in and adjustable tail piece connection
- ▶ True mechanical flush override
- ▶ Smart sensor with self-adjusting detection range and fuzzy logic control† to reduce water usage
- ▶ 6-second detection time to prevent ghost flushing
- ▶ ADA compliant
- ▶ Available in Polished Chrome (#CP) only

- ▶ Manual operated, non-hold open, urinal flush valve complete with 3/4" angle stop and 3/4" or 1-1/4" vacuum breaker set
- ▶ Piston valve action with 0.5/1.0 gpf
- ▶ Left/right rough-in
- ▶ Top spud exposed
- ▶ ADA compliant
- ▶ Available in Polished Chrome (#CP) only

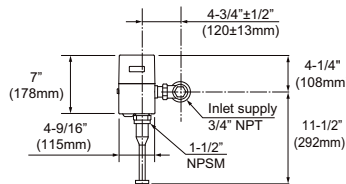
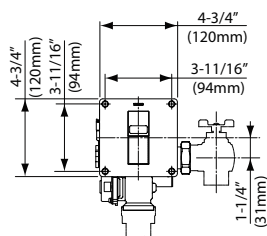
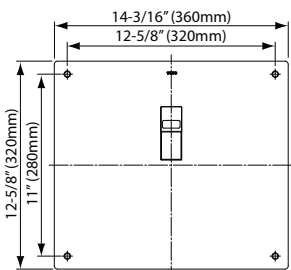
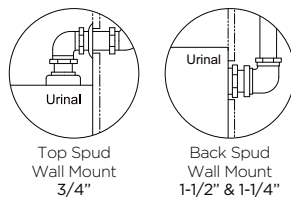
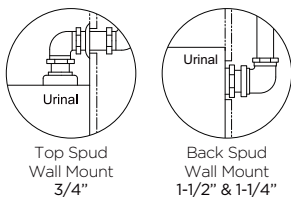

AVAILABLE FINISHES



*Only applies to 0.5 GPF & 0.125 GPF urinal flush valves.
 †Only applies to 0.125 GPF urinal flush valves.
 ‡ Feature available on specific models.



Product Shown: Helix® ECOPOWER® Faucet

COMMERCIAL ECOPOWER® FAUCETS

Innovation & Technology Highlights



ECOPOWER harnesses the energy of running water to power TOTO smart-sensor faucets or flush valves' electronics, replenishing them with every use. No minimum daily usage requirement, which translates into **reduced electricity use**, lower maintenance costs, and better ecology.

ECOPOWER ADVANTAGE

- ▶ Sustainably engineered to require no external electricity source
- ▶ Hydropower system needs no routine battery replacement which lowers maintenance costs
- ▶ Strategically placed sensor ensures instantaneous water response, minimizing water wastage
- ▶ Hands-free operation reduces the chance of spreading contaminants

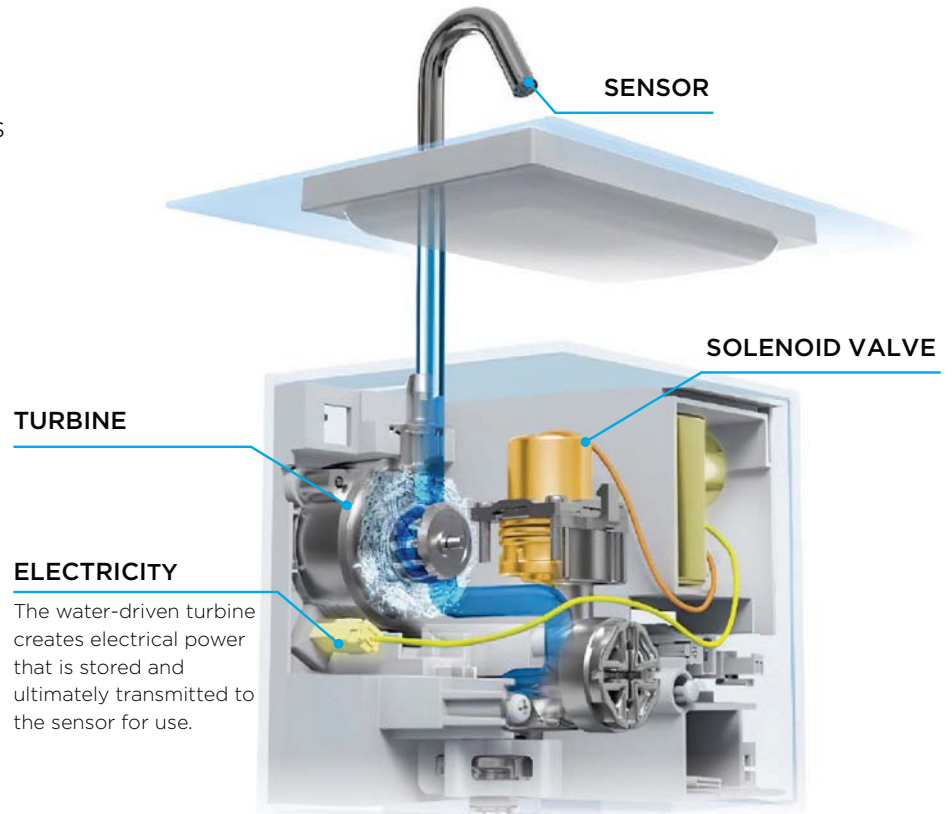

TOTO COMMERCIAL PERFORMANCE

A WIN-WIN. Unlike other sensor faucets, ECOPOWER faucets use hydropower to operate the sensor. The flow of water, which meets the most rigorous water saving standards, spins the high-efficiency turbine to both create and store power for operation. TOTO's proprietary sensor technology has been perfected over the past 15 years.

ECOPOWER® OR AC
TOUCHLESS FAUCET
0.35 GPM / 1.0 GPM

KIT (INCLUDES SPOUT & CONTROLLER)

**0.12 GPC, (20 SEC-ON DEMAND)
@ 0.35 GPM** **0.18 GPC, (10 SEC-ON DEMAND)
@ 1.0 GPM**

PRODUCT	SPOUT	TYPE	SINGLE SUPPLY	HOT/COLD MIXING VALVE	THERMOSTATIC MIXING VALVE	SPOUT	TYPE	SINGLE SUPPLY	HOT/COLD MIXING VALVE	THERMOSTATIC MIXING VALVE	
				TLM10	TLE05701U				TLM10	TLE05701U	
Axiom	TLE25001U2	ECOPOWER	T25S32E#CP	T25S32EM#CP	T25S32ET#CP						
		AC	T25S32A#CP	T25S32AM#CP	T25S32AT#CP						
Axiom Vessel	TLE25003U2	ECOPOWER	T25T32E#CP	T25T32EM#CP	T25T32ET#CP						
		AC	T25T32A#CP	T25T32AM#CP	T25T32AT#CP						
Axiom Wall-Mount	TLE25005U2	ECOPOWER	T25L32E#CP	T25L32EM#CP	T25L32ET#CP						
		AC	T25L32A#CP	T25L32AM#CP	T25L32AT#CP						
GC	TLE21001U2	ECOPOWER	T21S32E#CP	T21S32EM#CP	T21S32ET#CP						
		AC	T21S32A#CP	T21S32AM#CP	T21S32AT#CP						
GE	TLE20001U2	ECOPOWER	T20S32E#CP	T20S32EM#CP	T20S32ET#CP						
		AC	T20S32A#CP	T20S32AM#CP	T20S32AT#CP						
GM	TLE22001U2	ECOPOWER	T22S32E#CP	T22S32EM#CP	T22S32ET#CP						
		AC	T22S32A#CP	T22S32AM#CP	T22S32AT#CP						
Gooseneck	TLE24001U2	ECOPOWER	T24S32E#CP	T24S32EM#CP	T24S32ET#CP						
		AC	T24S32A#CP	T24S32AM#CP	T24S32AT#CP						
Gooseneck Vessel	TLE24003U2	ECOPOWER	T24T32E#CP	T24T32EM#CP	T24T32ET#CP						
		AC	T24T32A#CP	T24T32AM#CP	T24T32AT#CP						
Helix	TLE26001U2	ECOPOWER	T26S32E#CP	T26S32EM#CP	T26S32ET#CP						
		AC	T26S32A#CP	T26S32AM#CP	T26S32AT#CP						
Helix Vessel	TLE26003U2	ECOPOWER	T26T32E#CP	T26T32EM#CP	T26T32ET#CP						
		AC	T26T32A#CP	T26T32AM#CP	T26T32AT#CP						
Helix Wall Mount	TLE26005U2	ECOPOWER	T26L32E#CP	T26L32EM#CP	T26L32ET#CP						
		AC	T26L32A#CP	T26L32AM#CP	T26L32AT#CP						
Libella Semi-Vessel	TLE23002U2	ECOPOWER	T23M32E#CP	T23M32EM#CP	T23M32ET#CP						
		AC	T23M32A#CP	T23M32AM#CP	T23M32AT#CP						
Libella Wall-Mount	TLE23005U2	ECOPOWER	T23L32E#CP	T23L32EM#CP	T23L32ET#CP						
		AC	T23L32A#CP	T23L32AM#CP	T23L32AT#CP						
Standard-R	TLE28001U2	ECOPOWER	T28S32E#CP	T28S32EM#CP	T28S32ET#CP	TLE28003U1		ECOPOWER	T28S11E#CP	T28S11EM#CP	T28S11ET#CP
		AC	T28S32A#CP	T28S32AM#CP	T28S32AT#CP			AC	T28S11A#CP	T28S11AM#CP	T28S11AT#CP
Standard-S	TLE27001U2	ECOPOWER	T27S32E#CP	T27S32EM#CP	T27S32ET#CP	TLE27003U1		ECOPOWER	T27S11E#CP	T27S11EM#CP	T27S11ET#CP
		AC	T27S32A#CP	T27S32AM#CP	T27S32AT#CP			AC	T27S11A#CP	T27S11AM#CP	T27S11AT#CP

AVAILABLE VALVES

HOT/COLD MIXING VALVE	THERMOSTATIC MIXING VALVE (FOR 0.35, 0.5 & 1.0 GPM FAUCETS)
TLM10	TLE05701U

ECOPOWER® OR AC
TOUCHLESS FAUCET
0.5 GPM

KIT (INCLUDES SPOUT & CONTROLLER)

**0.8 GPC, (10 SEC-ON DEMAND)
@ 0.5 GPM** **0.17 GPC, (20 SEC-CONTINUOUS)
@ 0.5 GPM**

PRODUCT	SPOUT	TYPE	0.8 GPC, (10 SEC-ON DEMAND) @ 0.5 GPM		0.17 GPC, (20 SEC-CONTINUOUS) @ 0.5 GPM					
			SINGLE SUPPLY	HOT/COLD MIXING VALVE	THERMOSTATIC MIXING VALVE	SPOUT	TYPE	SINGLE SUPPLY	HOT/COLD MIXING VALVE	THERMOSTATIC MIXING VALVE
				TLM10	TLE05701U				TLM10	TLE05701U
Axiom	TLE25006U1	ECOPOWER	T25S51E#CP	T25S51EM#CP	T25S51ET#CP	TLE25006U3	ECOPOWER	T25S53E#CP	T25S53EM#CP	T25S53ET#CP
		AC	T25S51A#CP	T25S51AM#CP	T25S51AT#CP		AC	T25S53A#CP	T25S53AM#CP	T25S53AT#CP
Axiom Vessel	TLE25008U1	ECOPOWER	T25T51E#CP	T25T51EM#CP	T25T51ET#CP	TLE25008U3	ECOPOWER	T25T53E#CP	T25T53EM#CP	T25T53ET#CP
		AC	T25T51A#CP	T25T51AM#CP	T25T51AT#CP		AC	T25T53A#CP	T25T53AM#CP	T25T53AT#CP
Axiom Wall-Mount	TLE25010U1	ECOPOWER	T25L51E#CP	T25L51EM#CP	T25L51ET#CP	TLE25010U3	ECOPOWER	T25L53E#CP	T25L53EM#CP	T25L53ET#CP
		AC	T25L51A#CP	T25L51AM#CP	T25L51AT#CP		AC	T25L53A#CP	T25L53AM#CP	T25L53AT#CP
GC	TLE21006U1	ECOPOWER	T21S51E#CP	T21S51EM#CP	T21S51ET#CP	TLE21006U3	ECOPOWER	T21S53E#CP	T21S53EM#CP	T21S53ET#CP
		AC	T21S51A#CP	T21S51AM#CP	T21S51AT#CP		AC	T21S53A#CP	T21S53AM#CP	T21S53AT#CP
GE	TLE20006U1	ECOPOWER	T20S51E#CP	T20S51EM#CP	T20S51ET#CP	TLE20006U3	ECOPOWER	T20S53E#CP	T20S53EM#CP	T20S53ET#CP
		AC	T20S51A#CP	T20S51AM#CP	T20S51AT#CP		AC	T20S53A#CP	T20S53AM#CP	T20S53AT#CP
GM	TLE22006U1	ECOPOWER	T22S51E#CP	T22S51EM#CP	T22S51ET#CP	TLE22006U3	ECOPOWER	T22S53E#CP	T22S53EM#CP	T22S53ET#CP
		AC	T22S51A#CP	T22S51AM#CP	T22S51AT#CP		AC	T22S53A#CP	T22S53AM#CP	T22S53AT#CP
Gooseneck	TLE24006U1	ECOPOWER	T24S51E#CP	T24S51EM#CP	T24S51ET#CP	TLE24006U3	ECOPOWER	T24S53E#CP	T24S53EM#CP	T24S53ET#CP
		AC	T24S51A#CP	T24S51AM#CP	T24S51AT#CP		AC	T24S53A#CP	T24S53AM#CP	T24S53AT#CP
Gooseneck Vessel	TLE24008U1	ECOPOWER	T24T51E#CP	T24T51EM#CP	T24T51ET#CP	TLE24008U3	ECOPOWER	T24T53E#CP	T24T53EM#CP	T24T53ET#CP
		AC	T24T51A#CP	T24T51AM#CP	T24T51AT#CP		AC	T24T53A#CP	T24T53AM#CP	T24T53AT#CP
Helix	TLE26006U1	ECOPOWER	T26S51E#CP	T26S51EM#CP	T26S51ET#CP	TLE26006U3	ECOPOWER	T26S53E#CP	T26S53EM#CP	T26S53ET#CP
		AC	T26S51A#CP	T26S51AM#CP	T26S51AT#CP		AC	T26S53A#CP	T26S53AM#CP	T26S53AT#CP
Helix Vessel	TLE26008U1	ECOPOWER	T26T51E#CP	T26T51EM#CP	T26T51ET#CP	TLE26008U3	ECOPOWER	T26T53E#CP	T26T53EM#CP	T26T53ET#CP
		AC	T26T51A#CP	T26T51AM#CP	T26T51AT#CP		AC	T26T53A#CP	T26T53AM#CP	T26T53AT#CP
Helix Wall-Mount	TLE26010U1	ECOPOWER	T26L51E#CP	T26L51EM#CP	T26L51ET#CP	TLE26010U3	ECOPOWER	T26L53E#CP	T26L53EM#CP	T26L53ET#CP
		AC	T26L51A#CP	T26L51AM#CP	T26L51AT#CP		AC	T26L53A#CP	T26L53AM#CP	T26L53AT#CP
Libella Semi-Vessel	TLE23007U1	ECOPOWER	T23M51E#CP	T23M51EM#CP	T23M51ET#CP	TLE23007U3	ECOPOWER	T23M53E#CP	T23M53EM#CP	T23M53ET#CP
		AC	T23M51A#CP	T23M51AM#CP	T23M51AT#CP		AC	T23M53A#CP	T23M53AM#CP	T23M53AT#CP
Libella Wall-Mount	TLE23010U1	ECOPOWER	T23L51E#CP	T23L51EM#CP	T23L51ET#CP	TLE23010U3	ECOPOWER	T23L53E#CP	T23L53EM#CP	T23L53ET#CP
		AC	T23L51A#CP	T23L51AM#CP	T23L51AT#CP		AC	T23L53A#CP	T23L53AM#CP	T23L53AT#CP
Standard-R	TLE28002U1	ECOPOWER	T28S51E#CP	T28S51EM#CP	T28S51ET#CP	TLE28002U3	ECOPOWER	T28S53E#CP	T28S53EM#CP	T28S53ET#CP
		AC	T28S51A#CP	T28S51AM#CP	T28S51AT#CP		AC	T28S53A#CP	T28S53AM#CP	T28S53AT#CP
Standard-R EWATER+®	TLE31002U1	AC	T28S51S#CP	T28S51SM#CP	T28S51ST#CP					
Standard-S	TLE27002U1	ECOPOWER	T27S51E#CP	T27S51EM#CP	T27S51ET#CP	TLE27002U3	ECOPOWER	T27S53E#CP	T27S53EM#CP	T27S53ET#CP
		AC	T27S51A#CP	T27S51AM#CP	T27S51AT#CP		AC	T27S53A#CP	T27S53AM#CP	T27S53AT#CP

AVAILABLE VALVES

HOT/COLD MIXING VALVE	THERMOSTATIC MIXING VALVE (FOR 0.35, 0.5 & 1.0 GPM FAUCETS)
TLM10	TLE05701U

GPC (Gallons Per Cycle) | GPM (Gallons Per Minute)

TOUCHLESS FAUCETS OVERVIEW

GE
ECOPOWER FAUCET
 T20S51E (0.5 GPM/0.09 GPC)
 T20S53E (0.5 GPM/0.19 GPC)
 T20S32E (0.35 GPM/0.12 GPC)
AC POWER FAUCET
 T20S51A (0.5 GPM/0.09 GPC)
 T20S53A (0.5 GPM/0.19 GPC)
 T20S32A (0.35 GPM/0.12 GPC)



GM
ECOPOWER FAUCET
 T22S32E (0.5 GPM/0.09 GPC)
 T22S51E (0.5 GPM/0.19 GPC)
 T22S53E (0.35 GPM/0.12 GPC)
AC POWER FAUCET
 T22S32A (0.5 GPM/0.09 GPC)
 T22S51A (0.5 GPM/0.19 GPC)
 T22S53A (0.35 GPM/0.12 GPC)



reddot winner 2021

GOOSENECK
ECOPOWER FAUCET
 T24S51E (0.5 GPM/0.09 GPC)
 T24S53E (0.5 GPM/0.19 GPC)
 T24S32E (0.35 GPM/0.12 GPC)
AC POWER FAUCET
 T24S51A (0.5 GPM/0.09 GPC)
 T24S53A (0.5 GPM/0.19 GPC)
 T24S32A (0.35 GPM/0.12 GPC)



reddot winner 2021
 best of the best

GOOSENECK VESSEL
ECOPOWER FAUCET
 T24T51E (0.5 GPM/0.09 GPC)
 T24T53E (0.5 GPM/0.19 GPC)
 T24T32E (0.35 GPM/0.12 GPC)
AC POWER FAUCET
 T24T51A (0.5 GPM/0.09 GPC)
 T24T53A (0.5 GPM/0.19 GPC)
 T24T32A (0.35 GPM/0.12 GPC)



reddot winner 2021
 best of the best



- ▶ The choice of self-generating hydropowered ECOPOWER® system or AC system
- ▶ Micro-sensor positioned underneath the spout head provides accurate hand detection and ensures smooth, consistent water distribution
- ▶ Vandal resistant nozzle
- ▶ Aerated flow
- ▶ Durable chrome plated spout body
- ▶ Kit includes spout body, controller box, and mounting hardware (supply lines not included)
- ▶ 0.35 gpm aerated flow
- ▶ Contributes to earning LEED® credits
- ▶ Equipped with 0.35 gpm flow control. 0.12 gpc, 20 sec on-demand flow

- ▶ The choice of self-generating hydropowered ECOPOWER system or AC system
- ▶ Micro-sensor positioned underneath the spout head provides accurate hand detection and ensures smooth, consistent water distribution
- ▶ Vandal resistant nozzle
- ▶ Aerated flow
- ▶ Durable chrome plated spout body
- ▶ Kit includes spout body, controller box, and mounting hardware (supply lines not included)
- ▶ 0.35 gpm aerated flow
- ▶ Contributes to earning LEED credits
- ▶ Equipped with 0.35 gpm flow control. 0.12 gpc, 20 sec on-demand flow

- ▶ The choice of self-generating hydropowered ECOPOWER system or AC system
- ▶ Micro-sensor positioned underneath the spout head provides accurate hand detection and ensures smooth, consistent water distribution
- ▶ SOFT FLOW™ flow for strong water flow without the backsplash
- ▶ Laminar flow
- ▶ Durable chrome plated spout body
- ▶ Kit includes spout body, controller box, and mounting hardware (supply lines not included)
- ▶ 0.35 gpm aerated flow
- ▶ Contributes to earning LEED credits
- ▶ Equipped with 0.35 gpm flow control. 0.12 gpc, 20 sec on-demand flow

- ▶ The choice of self-generating hydropowered ECOPOWER system or AC system
- ▶ Micro-sensor positioned underneath the spout head provides accurate hand detection and ensures smooth, consistent water distribution
- ▶ SOFT FLOW flow for strong water flow without the backsplash
- ▶ Laminar flow
- ▶ Durable chrome plated spout body
- ▶ Kit includes spout body, controller box, and mounting hardware (supply lines not included)
- ▶ 0.35 gpm aerated flow
- ▶ Contributes to earning LEED credits
- ▶ Equipped with 0.35 gpm flow control. 0.12 gpc, 20 sec on-demand flow

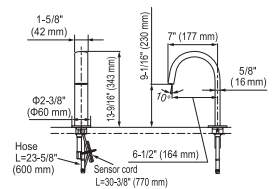
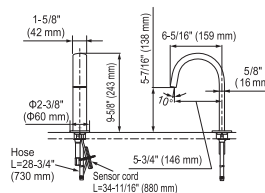
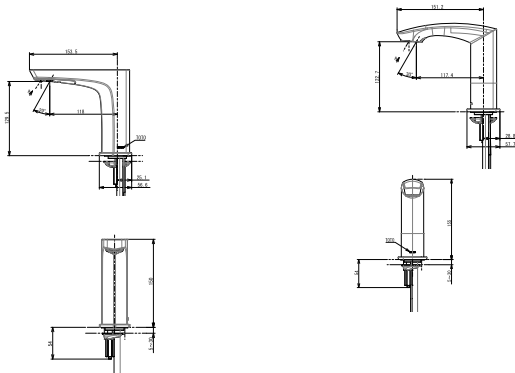

For more information on dimensions please refer to product spec sheet.

AVAILABLE
FINISH



TOUCHLESS FAUCETS OVERVIEW

HELIX® ECOPOWER FAUCET

T26S51E (0.5 GPM/0.09 GPC)
T26S53E (0.5 GPM/0.19 GPC)
T26S32E (0.35 GPM/0.12 GPC)

AC POWER FAUCET

T26S51A (0.5 GPM/0.09 GPC)
T26S53A (0.5 GPM/0.19 GPC)
T26S32A (0.35 GPM/0.12 GPC)



- ▶ The choice of self-generating hydropowered ECOPOWER® system or AC system
- ▶ Micro-sensor positioned underneath the spout head provides accurate hand detection and ensures smooth, consistent water distribution
- ▶ Vandal resistant nozzle
- ▶ Aerated flow
- ▶ Durable chrome plated spout body
- ▶ Kit includes spout body, controller box, and mounting hardware (supply lines not included)
- ▶ 0.35 gpm aerated flow
- ▶ Contributes to earning LEED® credits
- ▶ Equipped with 0.35 gpm flow control. 0.12 gpc, 20 sec on-demand flow

HELIX VESSEL ECOPOWER FAUCET

T26T51E (0.5 GPM/0.09 GPC)
T26T53E (0.5 GPM/0.19 GPC)
T26T32E (0.35 GPM/0.12 GPC)

AC POWER FAUCET

T26T51A (0.5 GPM/0.09 GPC)
T26T53A (0.5 GPM/0.19 GPC)
T26T32A (0.35 GPM/0.12 GPC)



- ▶ The choice of self-generating hydropowered ECOPOWER® system or AC system
- ▶ Micro-sensor positioned underneath the spout head provides accurate hand detection and ensures smooth, consistent water distribution
- ▶ Vandal resistant nozzle
- ▶ Aerated flow
- ▶ Durable chrome plated spout body
- ▶ Kit includes spout body, controller box, and mounting hardware (supply lines not included)
- ▶ 0.35 gpm aerated flow
- ▶ Contributes to earning LEED® credits
- ▶ Equipped with 0.35 gpm flow control. 0.12 gpc, 20 sec on-demand flow

HELIX WALL-MOUNT ECOPOWER FAUCET

T26L51E (0.5 GPM/0.09 GPC)
T26L53E (0.5 GPM/0.19 GPC)
T26L32E (0.35 GPM/0.12 GPC)

AC POWER FAUCET

T26L51A (0.5 GPM/0.09 GPC)
T26L53A (0.5 GPM/0.19 GPC)
T26L32A (0.35 GPM/0.12 GPC)



- ▶ The choice of self-generating hydropowered ECOPOWER® system or AC system
- ▶ Micro-sensor positioned underneath the spout head provides accurate hand detection and ensures smooth, consistent water distribution
- ▶ Vandal resistant nozzle
- ▶ Aerated flow
- ▶ Durable chrome plated spout body
- ▶ Kit includes spout body, controller box, and mounting hardware (supply lines not included)
- ▶ 0.35 gpm aerated flow
- ▶ Contributes to earning LEED® credits
- ▶ Equipped with 0.35 gpm flow control. 0.12 gpc, 20 sec on-demand flow

LIBELLA® SEMI-VESSEL ECOPOWER FAUCET

T23M51E (0.5 GPM/0.09 GPC)
T23M53E (0.5 GPM/0.19 GPC)
T23M32E (0.35 GPM/0.12 GPC)

AC POWER FAUCET

T23M51A (0.5 GPM/0.09 GPC)
T23M53A (0.5 GPM/0.19 GPC)
T23M32A (0.35 GPM/0.12 GPC)



- ▶ The choice of self-generating hydropowered ECOPOWER® system or AC system
- ▶ Micro-sensor positioned underneath the spout head provides accurate hand detection and ensures smooth, consistent water distribution
- ▶ Vandal resistant nozzle
- ▶ Aerated flow
- ▶ Durable chrome plated spout body
- ▶ Kit includes spout body, controller box, and mounting hardware (supply lines not included)
- ▶ 0.35 gpm aerated flow
- ▶ Contributes to earning LEED® credits
- ▶ Equipped with 0.35 gpm flow control. 0.12 gpc, 20 sec on-demand flow

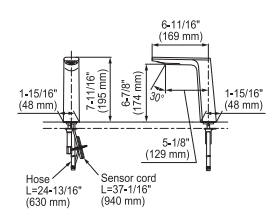
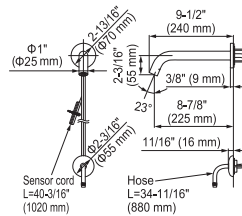
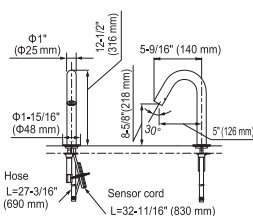
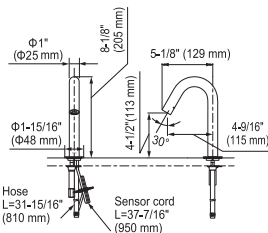

AVAILABLE
FINISH



For more information on dimensions please refer to product spec sheet.

LIBELLA® WALL-MOUNT L ECOPOWER FAUCET

- T23L51E (0.5 GPM/0.09 GPC)
- T23L53E (0.5 GPM/0.19 GPC)
- T23L32E (0.35 GPM/0.12 GPC)

AC POWER FAUCET

- T23L51A (0.5 GPM/0.09 GPC)
- T23L53A (0.5 GPM/0.19 GPC)
- T23L32A (0.35 GPM/0.12 GPC)



reddot winner 2021



- ▶ The choice of self-generating hydropowered ECOPOWER® system or AC system
- ▶ Micro-sensor positioned underneath the spout head provides accurate hand detection and ensures smooth, consistent water distribution
- ▶ Vandal resistant nozzle
- ▶ Aerated flow
- ▶ Durable chrome plated spout body
- ▶ Kit includes spout body, controller box, and mounting hardware (supply lines not included)
- ▶ Equipped with 0.5 gpm flow control. 0.08 gpc, 10 sec on-demand flow

STANDARD-R ECOPOWER FAUCET

- T28S11E (1.0GPM/0.18 GPC)
- T28S51E (0.5 GPM/0.09 GPC)
- T28S53E (0.5 GPM/0.19 GPC)
- T28S32E (0.35 GPM/0.12 GPC)

AC POWER FAUCET

- T28S11A (1.0GPM/0.18 GPC)
- T28S51A (0.5 GPM/0.09 GPC)
- T28S53A (0.5 GPM/0.19 GPC)
- T28S32A (0.35 GPM/0.12 GPC)

AC FAUCET + EWATER

- T28S51S (0.5 GPM/0.09 GPC)



- ▶ The choice of self-generating hydropowered ECOPOWER system or AC system
- ▶ Micro-sensor positioned underneath the spout head provides accurate hand detection and ensures smooth, consistent water distribution
- ▶ Vandal resistant nozzle
- ▶ Laminar flow
- ▶ Durable chrome plated spout body
- ▶ Kit includes spout body, controller box, and mounting hardware (supply lines not included)
- ▶ Equipped with 1.0 gpm flow control. 0.18 gpc, 10 sec on-demand flow
- ▶ AC FAUCET + EWATER Only applicable for 0.5gpm and AC type

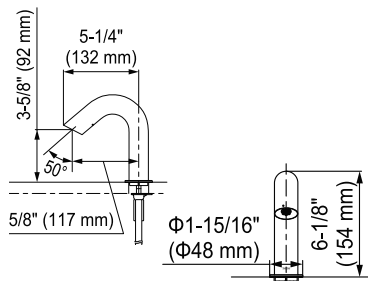

STANDARD-S ECOPOWER FAUCET

- T27S11E (1.0 GPM)
- T27S51E (0.5 GPM/ 0.09 GPC)
- T27S53E (0.5 GPM/ 0.19 GPC)
- T27S32E (0.35 GPM/0.12 GPC)

AC POWER FAUCET

- T27S11A (1.0 GPM)
- T27S51A (0.5 GPM/ 0.09 GPC)
- T27S53A (0.5 GPM/ 0.19 GPC)
- T27S32A (0.35 GPM/0.12 GPC)



- ▶ The choice of self-generating hydropowered ECOPOWER system or AC system
- ▶ Micro-sensor positioned underneath the spout head provides accurate hand detection and ensures smooth, consistent water distribution
- ▶ Vandal resistant nozzle
- ▶ Laminar flow
- ▶ Durable chrome plated spout body
- ▶ Kit includes spout body, controller box, and mounting hardware (supply lines not included)
- ▶ Equipped with 1.0 gpm flow control. 0.18 gpc, 10 sec on-demand flow

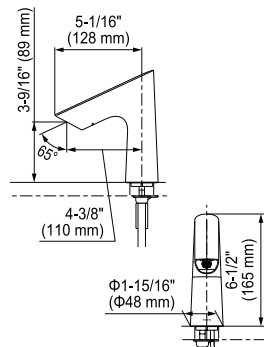

TOUCHLESS FAUCET CONTROLLER WITH HEATER FAUCET CONTROLLER
REAH03B1U



- ▶ INTEGRATED hot water system and TOUCHLESS Faucet Controller. (Integrated thermostatic mixing valve is ASSE 1070 compliant.)
- ▶ ECOLOGICAL WITH POWER SAVINGS / Find a time when hot water usage is low and save energy
- ▶ EASY TO INSTALL / Hot water piping system, T&P relief valve and expansion tank are NOT required
- ▶ EASY TO MAINTAIN / No periodical replacement parts
- ▶ SAFETY DESIGN / Tank and Heating element are made of high corrosion-resistance stainless steel
- ▶ EQUIPPED with burnout prevention control of heater elements
- ▶ COMPACT DESIGN / Allows for ADA compliance.
- ▶ For use with 0.5 gpm flow control, 0.08 gpc, 10 sec on-demand flow TOTO Touchless Faucet

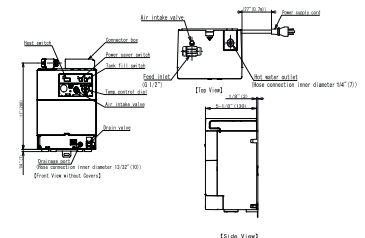

For more information on dimensions please refer to product spec sheet.

AVAILABLE FINISH





Products shown: Standard-R Touchless Faucet and Touchless Soap Dispenser



HANDS-FREE SOAP DISPENSERS

TOTO soap dispensers offer touchless operation with foaming soap for a hygienic handwashing experience.

TOUCHLESS

SOAP DISPENSER

- TES201AE (1 spout)
- TES202AE (2 spouts)
- TES203AE (3 spouts)

SOAP DISPENSER WITH SUBTANK

- TES204AE (2 spouts)
- TES205AE (3 spouts)



TOUCHLESS

SOAP DISPENSER - VESSEL

- TES201AG (2 spouts)
- TES202AG (3 spouts)
- TES203AG (4 spouts)

SOAP DISPENSER WITH SUBTANK

- TES204AG (2 spouts)
- TES205AG (3 spouts)



TOUCHLESS

SOAP DISPENSER - ROUND

- TES201AB (1 spout)
- TES202AB (2 spouts)
- TES203AB (3 spouts)

SOAP DISPENSER - ROUND WITH SUBTANK

- TES204AB (2 spouts)
- TES205AB (3 spouts)



TOUCHLESS

SOAP DISPENSER - SEMI-VESSEL

- TES201AF (1 spout)
- TES204AF (2 spouts)
- TES205AF (3 spouts)

SOAP DISPENSER WITH SUBTANK

- TES204AF (2 spouts)
- TES205AF (3 spouts)



TOUCHLESS

SOAP DISPENSER - ROUND VESSEL

- TES201AD (1 spout)
- TES202AD (2 spouts)
- TES203AD (3 spouts)

SOAP DISPENSER - ROUND VESSEL WITH SUBTANK

- TES204AD (2 spouts)
- TES205AD (3 spouts)



- TOTO's IoT Soap Dispenser alerts your team when the dispenser needs to be refilled or if the controller is leaking
- Micro-sensor under the spout ensures accurate hand detection
- Auto-purge cycle prevents soap from clogging the spout



SCAN CODE TO VIEW SOAP DISPENSERS

TOTO® SOAP 1 GALLON PACKAGE OF 4, 1 GAL. EACH TSFG1

- New FDA compliant, eco-friendly Triclosan-free formulation
- Antibacterial soap effectively reduces up to 99.999% of bacteria during use*
- Mild lotion soap suitable for daily use
- Use with foaming soap dispenser to create a rich lather for effective hand cleansing and to reduce water consumption

TOTO SCENTED SOAP 1 GALLON PACKAGE OF 4, 1 GAL. EACH TSFB1-GS

- Green Seal™ GS-41 certified
- No triclosan
- Biodegradable
- Helps qualify for LEED credits

COMMERCIAL LAVATORIES

Innovation & Technology Highlights

TOTO lavatories deliver the ideal combination of design and functionality. Available in a variety of styles from undercounter to self-rimming, our lavatories offer comfortable use for everyone, regardless of age or physical ability. They're the perfect choice for any commercial space, from hotels to public facilities.



Product shown:
Rectangle Undercounter Lavatory; LT1535G



**ADA
COMPLIANT**



The Americans with Disabilities Act (ADA) was enacted in 1990 to establish design codes to serve people of all ages and abilities. A core principle behind TOTO Total Design, ADA standards consider the needs of everyone, no matter their needs, without additional adaptation or specialization, optimizing the bathroom experience for all generations.

VESSEL LAVATORIES OVERVIEW

ARVINA®
RECTANGLE VESSEL
LAVATORY
LT415G

ARVINA
RECTANGLE VESSEL
LAVATORY
LT416G

ARVINA
RECTANGLE VESSEL
LAVATORY
LT425G

ARVINA
RECTANGLE VESSEL
LAVATORY
LT426G



- ▶ 19-11/16"W x 18-1/8"D x 2-3/4"H
- ▶ CEFIONTECT® ceramic glaze minimizes debris and mold from sticking to surface
- ▶ Inset faucet mount
- ▶ Thin, rounded edges achieving a decorative design
- ▶ Installation template included
- ▶ ADA compliant
- ▶ Front overflow
- ▶ Drain and faucet sold separately

- ▶ 23-5/8"W x 18-1/8"D x 2-3/4"H
- ▶ CEFIONTECT ceramic glaze minimizes debris and mold from sticking to surface
- ▶ Inset faucet mount
- ▶ Thin, rounded edges achieving a decorative design
- ▶ Installation template included
- ▶ ADA compliant
- ▶ Front overflow
- ▶ Drain and faucet sold separately

- ▶ 19-11/16"W x 14-15/16"D x 2-3/4"H
- ▶ CEFIONTECT ceramic glaze minimizes debris and mold from sticking to surface
- ▶ Thin, rounded edges achieving a decorative design
- ▶ Installation template included
- ▶ ADA compliant
- ▶ Front overflow
- ▶ Drain sold separately

- ▶ 23-5/8"W x 14-15/16"D x 2-3/4"H
- ▶ CEFIONTECT ceramic glaze minimizes debris and mold from sticking to surface
- ▶ Thin, rounded edges achieving a decorative design
- ▶ Installation template included
- ▶ ADA compliant
- ▶ Front overflow
- ▶ Drain sold separately

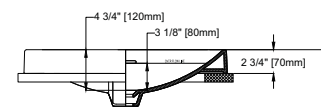
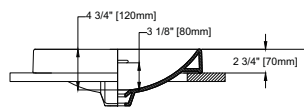
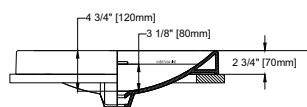
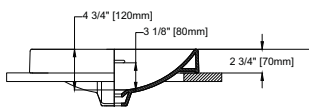
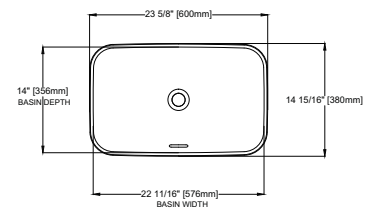
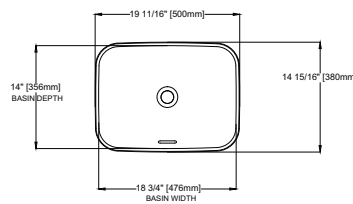
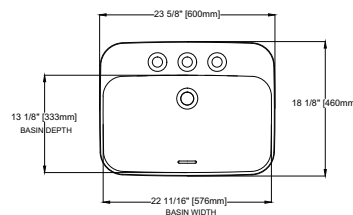
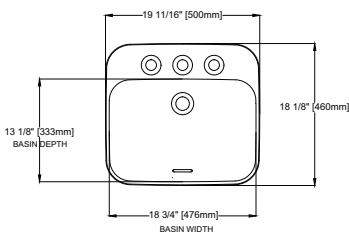

**AVAILABLE
COLOR**

#01
Cotton

For more information on dimensions please refer to product spec sheet.