

SW Honeycomb Querétaro

Erika Posadas / Oct 2024

Our global operating platform supports local implementation

60%

North America

7%

Latin America

32%

Europe, MEA,
and APAC

What is Honeycomb?

Breakdown

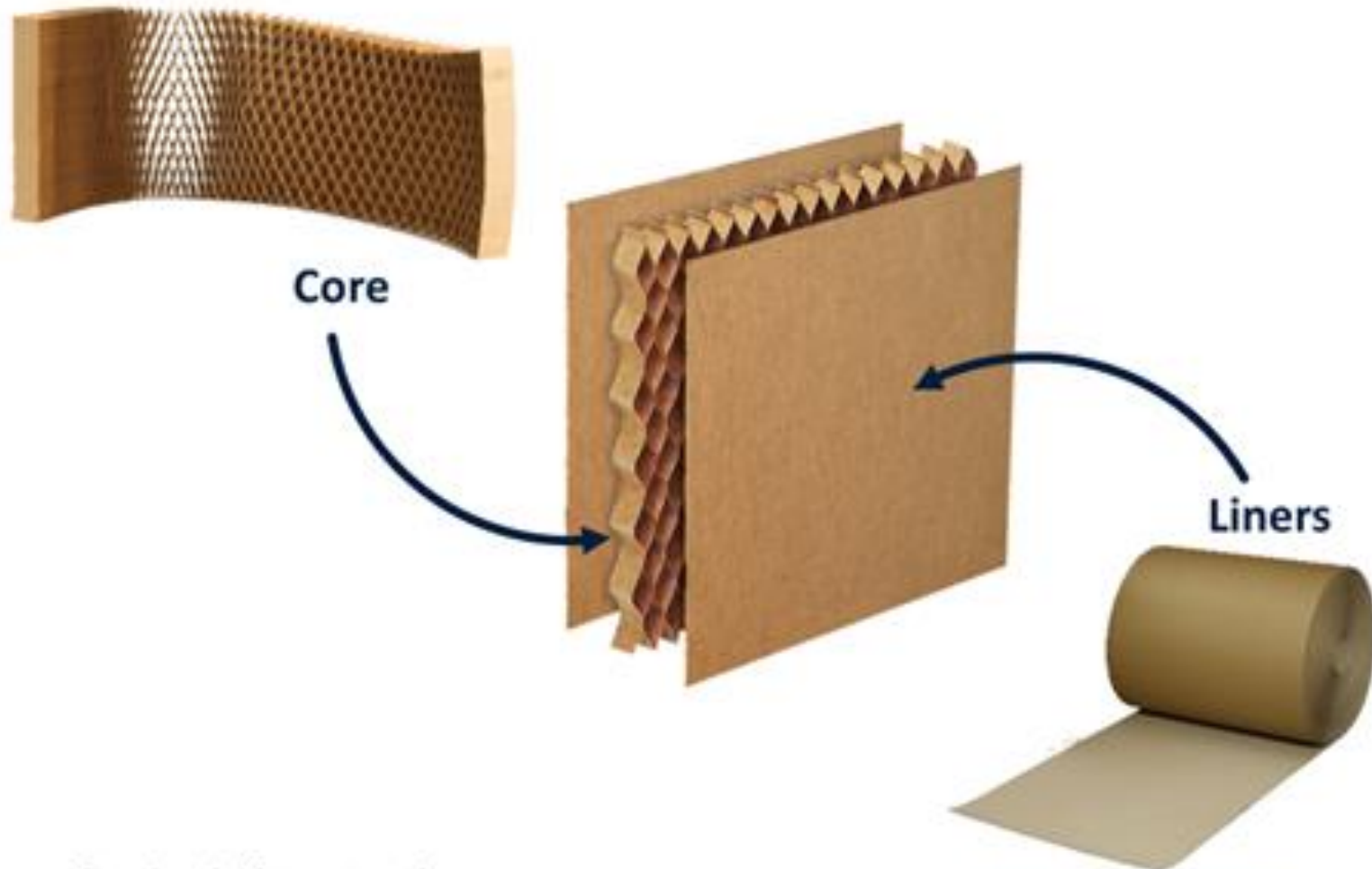

Creating the future together

PRIVATE & CONFIDENTIAL

Better Planet Packaging

Sustainable cargo protection portfolio

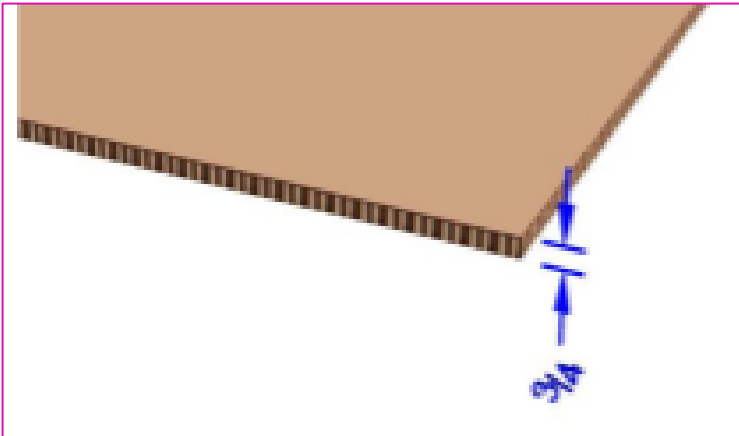

3/4" Honeycomb

- 48" x 108" x 0.75"
- Core type 4 (33 psi)
- Facings – Light
- Price \$6.97 USD/ea*

* DAP Zacatecas

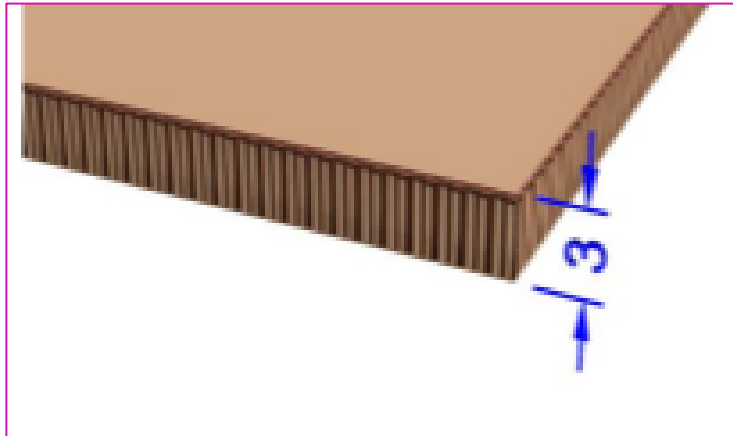

3" Honeycomb

- 48" x 108" x 3.00"
- Core type 5 (22 psi)
- Facings – Light
- Price \$15.07 USD/ea*

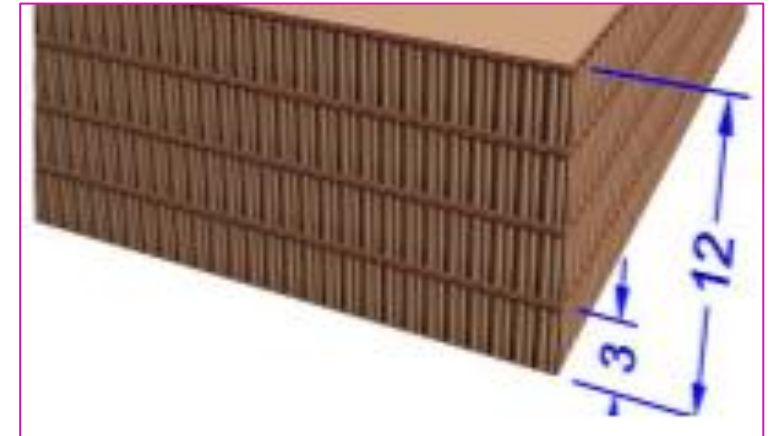

Honeycomb Void Filler

- 36" x 68" x 3.00" ~ 12.00"
- Core type 8 (11 psi)
- Facings – Light
- Price \$11.90 USD/ea*



Product balance delivers a comprehensive offering

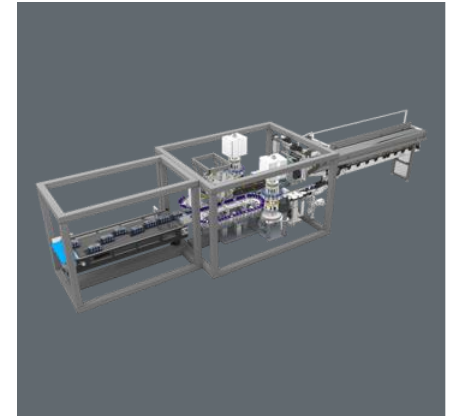
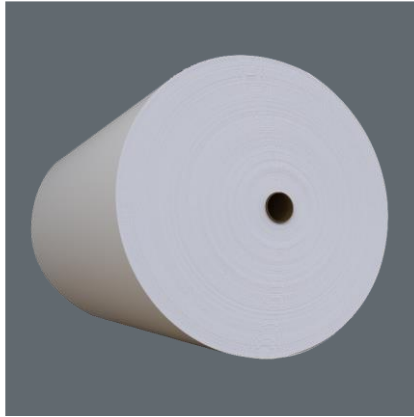

Paper & Board

Corrugated Packaging

Consumer Packaging

Specialty Packaging

Machinery & Automation

A shared commitment to success

Partnership towards the same goal



Display Pallets



EPS Substitution



EPS Substitution

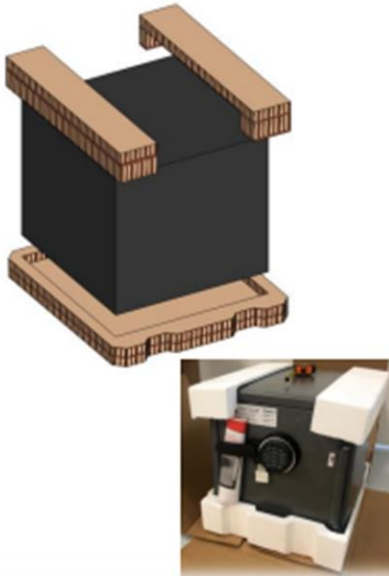

Inserts

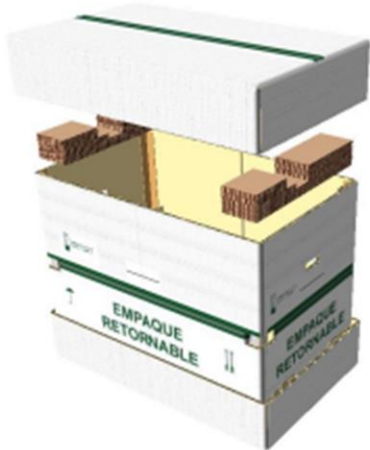

Bulk Liquids Solution





**We are committed
to being an
impactful
business and
supporting a
greener, bluer
planet.**



A shared commitment to success

Partnership towards the same goal

AB InBev Corona #BPP

Developing a plastic free pallet for Corona



Their Challenge

- ▶ A complete plastic free pallet for their Better World Packaging Project
- ▶ There was a wishlist of specs to fulfill. It needed to have the same strength as the pallet now and most important for this was the stack stability
- ▶ It was important that the chosen way can be automatized



Our Approach

- ▶ With the PES team, we made an overview of all possibilities:
- ▶ Corrugated hood, less plastic, toppsafe + straps
- ▶ We tested all these possibilities in our Development Centre
- ▶ Toppsafe gave a good result and is easy for automation



The Result



100% Better Planet Packaging

65% less plastic

Stack stability & Automation OK



- ▶ 35mm thick Honeycomb panel
- ▶ Size range: 600 to 1600 mm
- ▶ 2 or 4 angle board at the sides to strengthen for strapping
- ▶ Weight +/- 2 kg/sqm
- ▶ Weight range: 0.75 to 5.5 kg/TOPPSafe™
- ▶ Strapping strength up to 8kN
- ▶ Able to carry 3 pallets of 1.000 kg
- ▶ Bending stiff with 150mm underfill
- ▶ TOPPSafe™ branded topboards



Pain

Close up of bottles falling out of damaged pallet load

Case Study

- Honeycomb Monterrey / Constellations Brands
- Honeycomb QRO / ABInBev

Bumper cars

Hexacomb honeycomb panel and HexAir air bag system dramatically reduces rail car product damage for major U.S. beer importer.

Beverage and food companies frequently use rail cars to transport large pallet loads from bottling locations to various local distribution centers. Products transported by rail car can potentially incur damage during humping operations in railroad yards. Without proper cushioning, the intense shock affecting the load when rail cars bump into each other can result in substantial product damage.

When you are using thousands of rail cars per year to transport pallet loads, the cumulative result can be millions of dollars in product, time and labor loss.

This was exactly the experience that Crown Imports LLC, a division of Constellation Brands, Inc. was having several years ago. (Crown is the U.S. importer for the Grupo Modelo family of beer brands which includes Corona.) Mark McMillan, director of U.S. quality for Crown, was brought onboard to help address the problem.

Substantial damage, product loss

"The beers were being filled at Grupo Modelo's plants in Mexico. From there, we were importing them into the United States via rail, using approximately 37,000 box cars annually. The journey started in Mexico, then the cars would end up at one of our 12 U.S. distribution centers," McMillan explains. "With the exception of a couple of

Application snapshot:

Paper-based HEXACOMB® panels feature an engineered, proprietary honeycomb configuration.

- Panels are ideal for absorbing shock and vibration in rail and truck transport situations.



Without adequate protection, loads shift during transport causing pallet collapse and significant product damage.



Close up of bottles falling out of damaged pallet load.



Hexacomb panels, plus HexAir load containment system, dramatically reduce product damage.

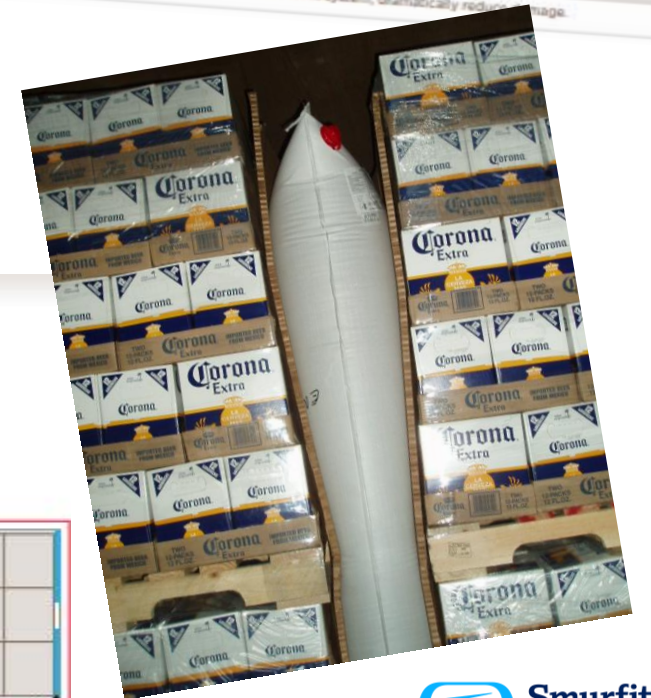

For a detailed dunnage configuration diagram, please see the graphic on page 3.

Railcar configuration

12-ounce long-neck glass bottle configuration for 12-pack cartons.

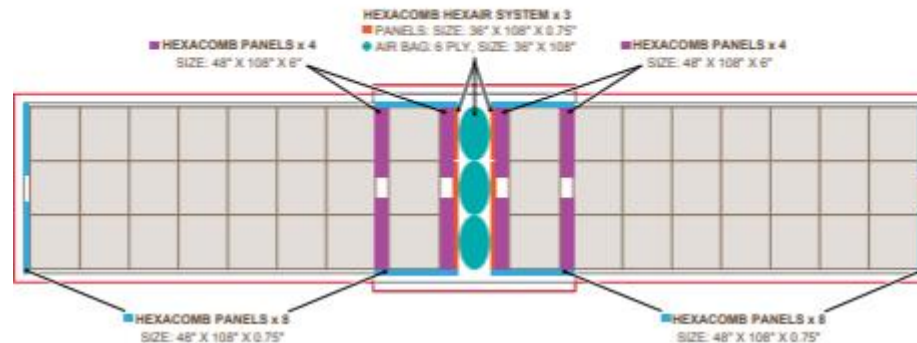

How will we win?

Products



Honeycomb



Molded Pulp
(2026)

Dunnage Honeycomb

Current Material

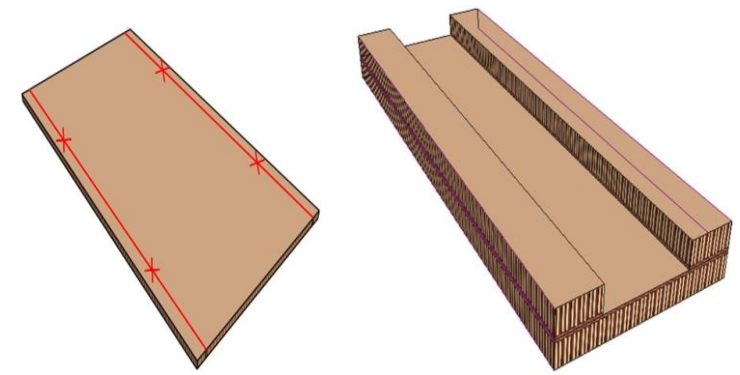

Dunnage de Honeycomb



Dunnage de Homeycomb



Donnage de EPS

Cargo Protection Solutions



Railroad



Trailer



Shipping Container



Void Fillers



TOPPSafe

Where are we



TOPPSafe™

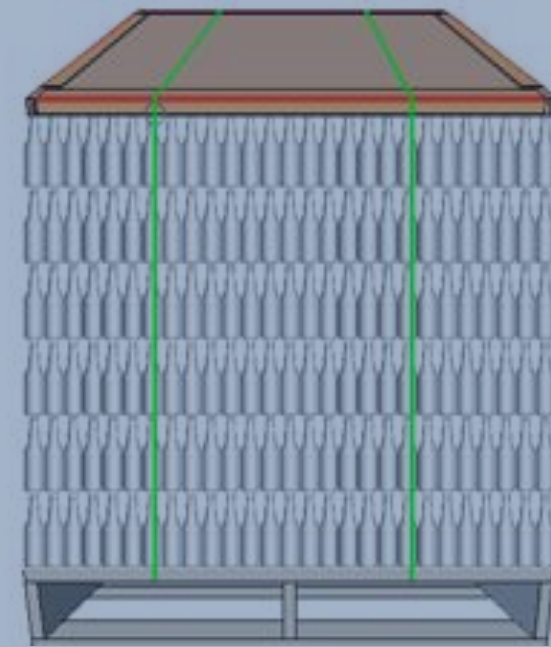
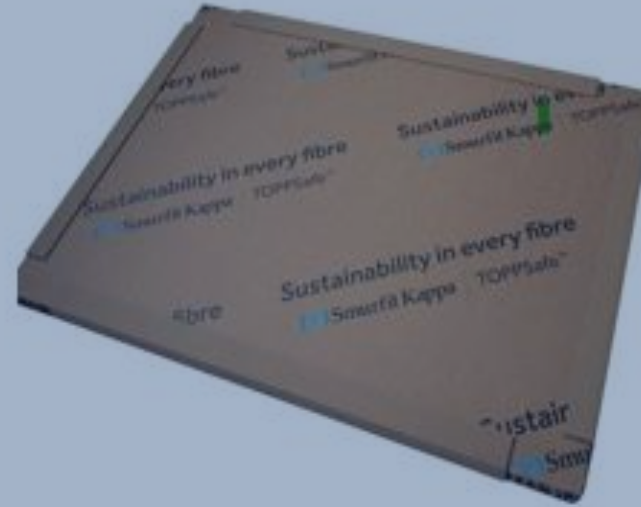

TOPP Safe

Total Cost
Savings

\$ 22.00

Marco de
madera

\$12.00

ToppSafe

24,000

Volumen Anual

\$528,000

VS

\$228,000

Gasto Anual



HC Pallet

\$ 20.00

Tarima de madera

\$14.00

Tarima HC

36,000

Volumen Anual

\$720,000

VS

\$504,000

Gasto Anual

PRODUCT CODE SK1 **HONEYCOMB PALLET SK1 40" X 48" X 5"**

DESCRIPTION Our standard size of the paper pallet is 40" x 48" x 5". The decks are manufactured with a honeycomb of 3/4" of thickness and protected by a sized paper board ideal to counter the humidity giving it competitive characteristics in the market. This product is accessible, certified in an external laboratory (3), it's environmentally friendly, recyclable(2), safe, economic, humidity resistant (5), firm, and lightweight.

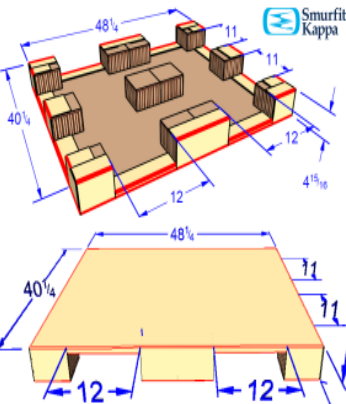

DATA SHEET (1) (3)	
Width	40.250"
Length	48.250"
Height	5.000"
Static Load	3000 KG
Dynamic Load	1500 KG
Weight	4.7 KG
Heat treatment	Exempt (4)
Fumigation	Exempt (4)
Exportable (4)	Complies with regulation ISPM-15
TRANSPORT	
PALLET	15 pzs
Truck 22.5ft	300 pzs
Trailer truck 53ft	780 pzs
Tolerances	
Length	0.25" +/-
Width	0.125" +/-
Thickness	0.030" +/-

IMPORTANT DATA

1) The pallet strength data are for reference only and are based on laboratory tests carried out according to the criteria of the Packaging Design Innovation Center and internal quality criteria. They were performed homogeneously load distribution, unified load, and controlled environmental conditions.

2) Made with 100% recycled raw materials. SK1 HEAVY is fully recyclable and complies with FSC MIXED and FSC RECYCLED certifications.

3) Endorsed by the ABRE center of the University of Monterrey. Document LAB 08 0045 22

4) Product is exempt of heat treatment and additional fumigation for export, according to the international standard ISPM-15

5) The SK HEAVY is made with a sized paper board and meets 30-40 COBB of the TAPPI T441 COBB test.



Confidentiality notice

The content of this presentation is proprietary and confidential information of Smurfit Westrock. The recipient may not distribute, copy, print or otherwise use information from this presentation without the written consent of Smurfit Westrock.

