

ZI 22 GROUP

Somos un grupo de dos divisiones

2D



3D

Disruptivos

Flexibles

Todo terreno

División 3D



1. **Diseño 3D y Modelado**
2. **Manufactura 3D**
3. **Escaneo 3D e Ingeniería Inversa**
4. **Elements**

Impresión 3D en la Industria 4.0

- Convierte un diseño 3d en un producto sin intervención
- Reduce el postprocesado, el desperdicio de material y la intervención humana.
- Permite la fabricación sin moldes.
- Aliada del medioambiente.



Impresión 3D en la Industria 4.0

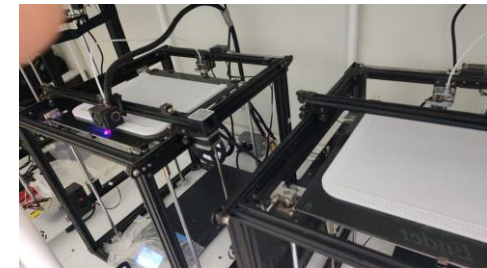
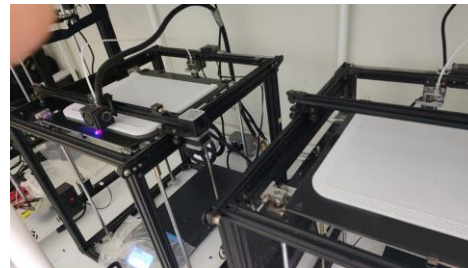
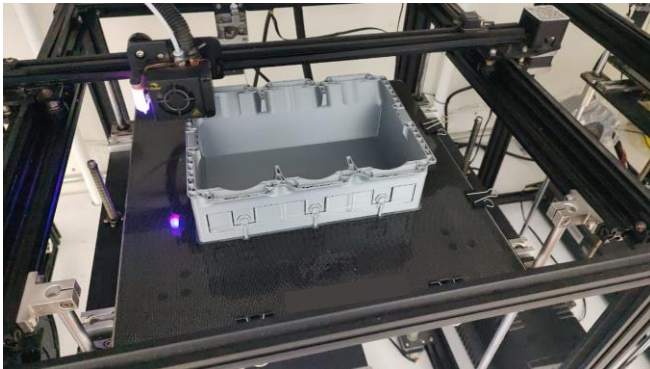
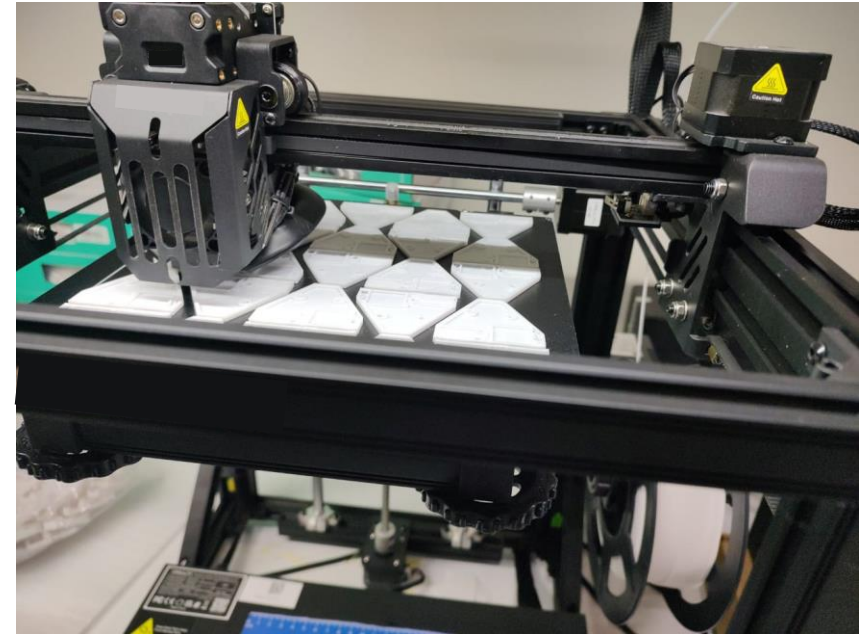
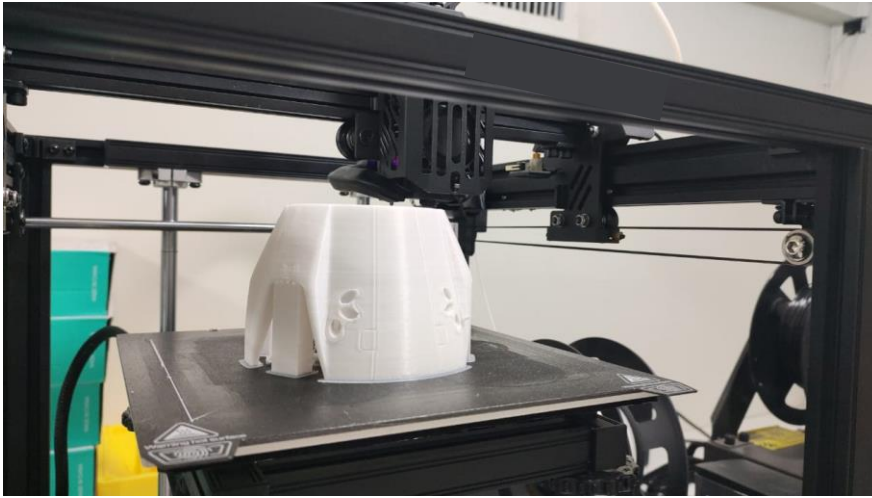

Manufactura Aditiva – Escaneo – Modelado

www.git3d.tech

Scaneo 3d, diseño e ingeniería inversa

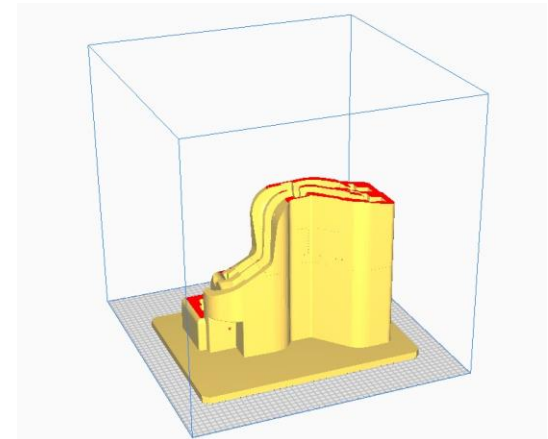
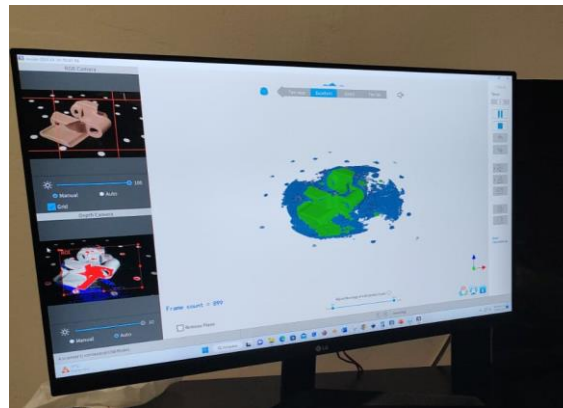
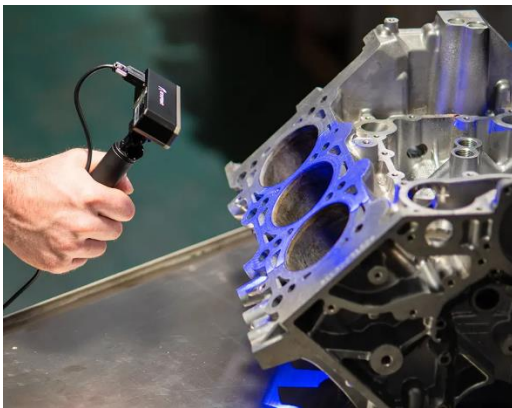
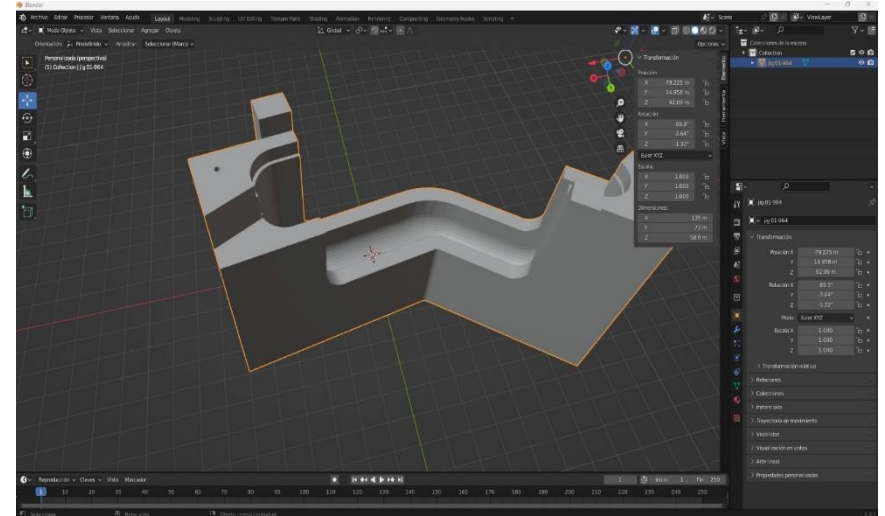

Manufactura Aditiva – Escaneo – Modelado

www.git3d.tech

Scaneo 3d, diseño e ingeniería inversa

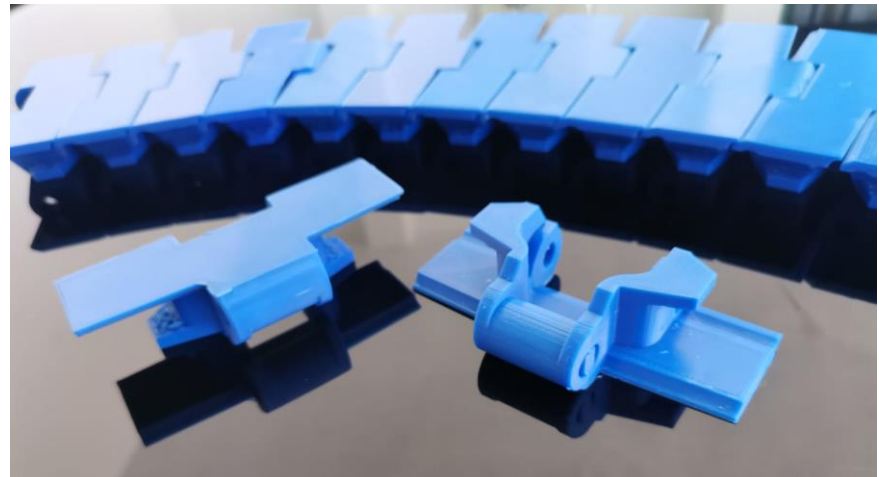
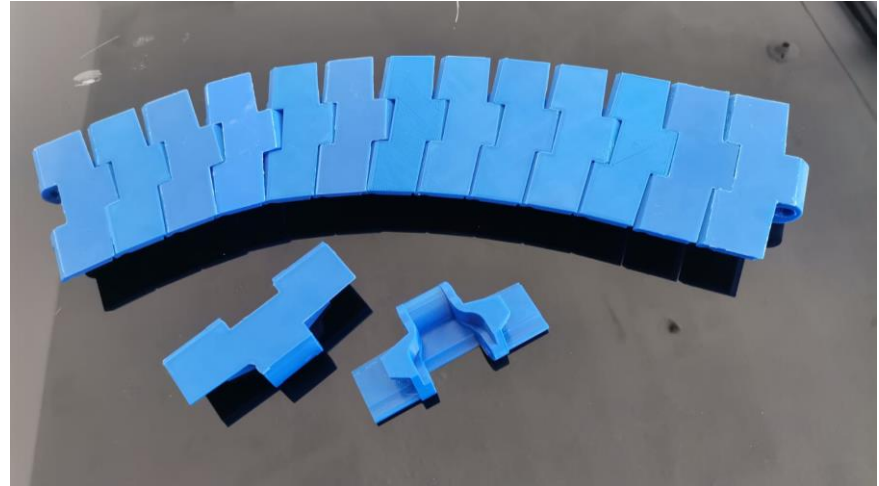
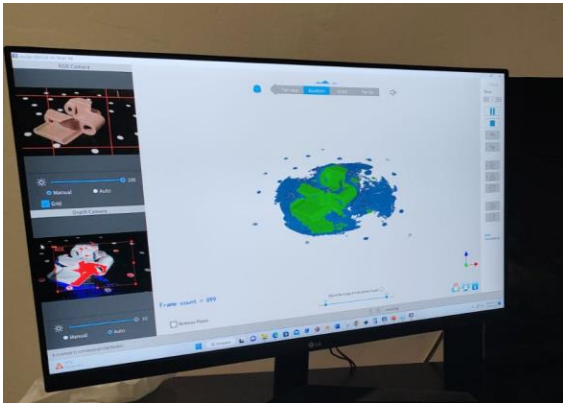

Reingeniería - mejora - ahorro

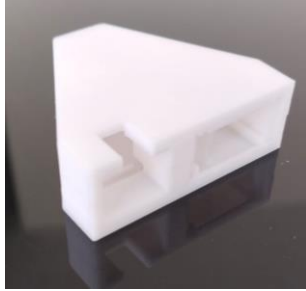

Soluciones a pequeños grandes problemas



Piezas de uso final

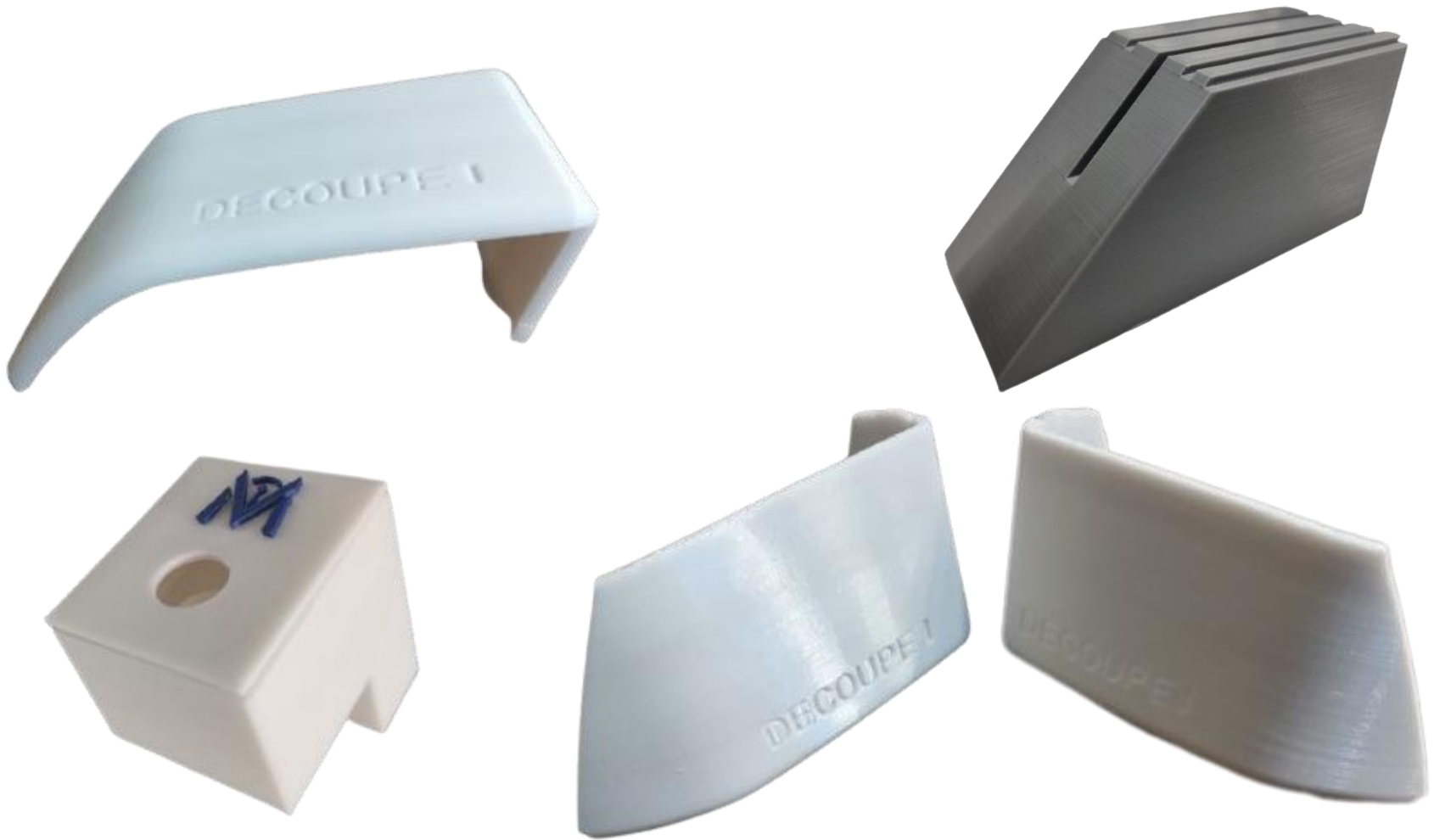

Cubiertas y guías de uso final



Manufactura Aditiva – Escaneo – Modelado

www.git3d.tech

Fixturas y prototipado



Manufactura Aditiva - Escaneo - Modelado

www.git3d.tech

Jigs y Clamps para tus procesos

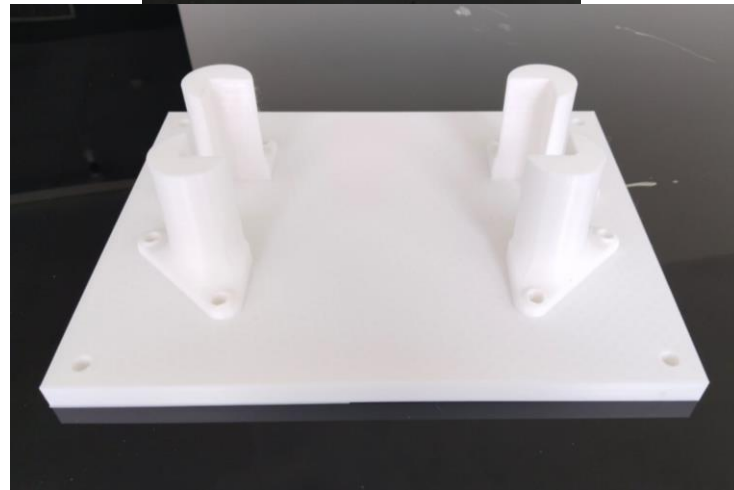
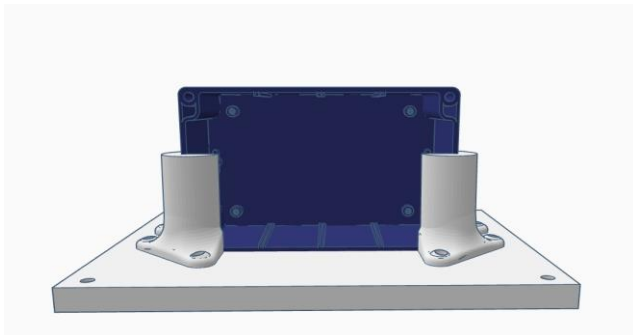
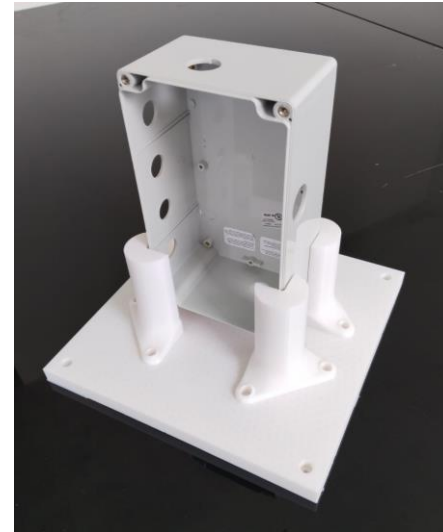
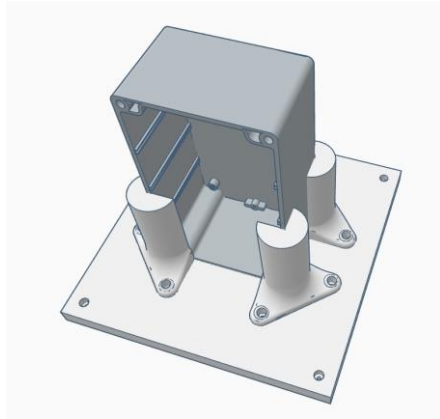

Carcasas para Botoneras



Manufactura Aditiva – Escaneo – Modelado

www.git3d.tech

Especialistas en aplicación



Manufactura Aditiva – Escaneo – Modelado

www.git3d.tech

Especialistas en aplicación



Diversidad de materiales

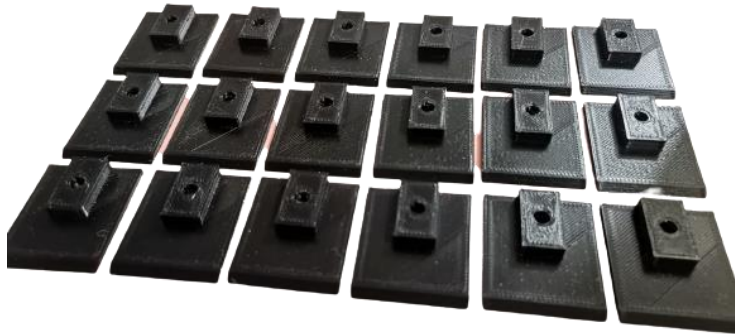

Diversidad de materiales

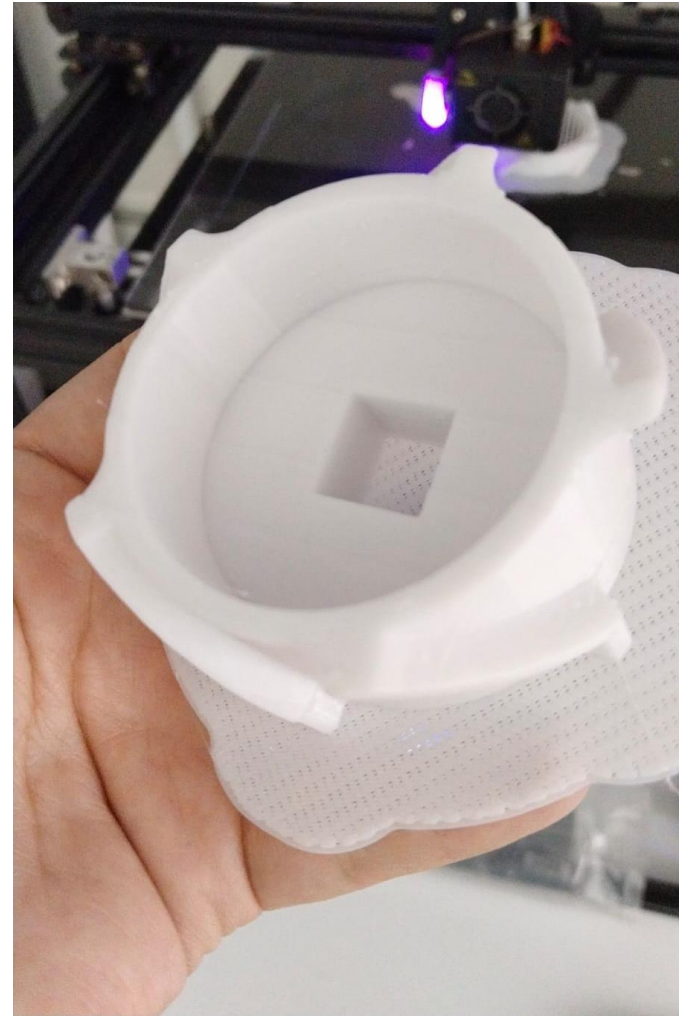
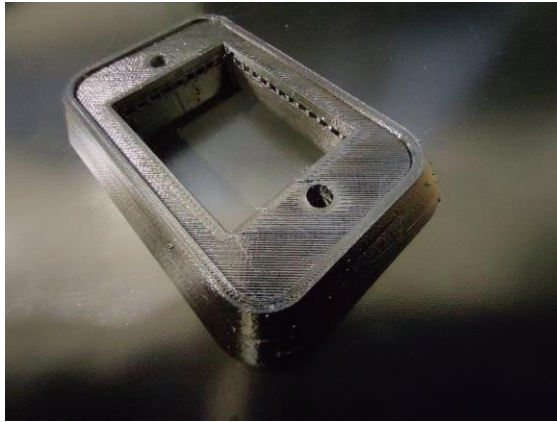

Fixturas y prototipado



Fixturas y prototipado



Manufactura Aditiva – Escaneo – Modelado

www.git3d.tech

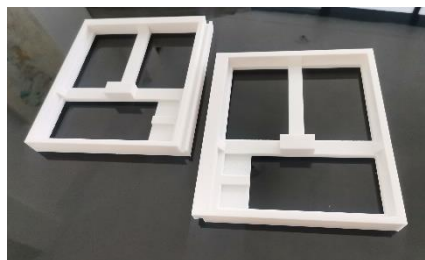



Manufactura Aditiva - Escaneo - Modelado

www.git3d.tech

Escalas



Letras y señalización



Manufactura Aditiva – Escaneo – Modelado

www.git3d.tech

Pensemos en 3D...



¿Porque elegirnos?

- Somos un grupo de negocios con 32 años en el mercado.
- Flexibilidad en el proceso de compras e impresión.
- Diferentes Tamaños de impresoras de hasta 50x50x60 cms.
- Asesoría e historial de compras.
- Acuerdos de confidencialidad.
- Asignamos impresoras para nuestros clientes.
- Conocimiento de procesos de compras.

Nuestros clientes



Manufactura Aditiva - Escaneo - Modelado

www.git3d.tech

ZI 22 GROUP



[Lasertonn](#) | [Chihuahua](#) | [Facebook](#)

Isla Sáenz

 **614 1421 38 62**



[GIT](#) | [Chihuahua](#) | [Facebook](#)

Aaron Torres

 **614 177 9861**

Manufactura Aditiva - Escaneo - Modelado
atorres@git3d.tech www.git3d.tech