

Nitto

Innovation for Customers

AUTOMOTIVE



Nitto

Innovation for Customers

Nitto Denko Corporation

26th Fl., Shinagawa Season Terrace, 1-2-70, Konan, Minato-ku, Tokyo 108-0075, Japan

TEL: +81-3-6632-2101 FAX: +81-3-6632-2025 <https://www.nitto.com/jp/en/>

CATALOG CODE: 20012 Issued in October 2020



0210F10 ©
1910R10 ©
2010R06

CONTENTS

PAGE	No.	PRODUCT NAME
------	-----	--------------

04 p Nitto Transportation Technical Center (NTTC)

PAGE	No.	PRODUCT NAME
------	-----	--------------

NVH, Waterproofing and Sealing Products

05 p	01	NITTO EPTSEALER® Sealing Material
06 p		How to Select NITTO EPTSEALER®
07 p	02	No. 6800 Series NITTO EPTSEALER®
	03	No. 685 Series NITTO EPTSEALER®
08 p	04	EE-1000 Series NITTO EPTSEALER®
	05	EV1000 Series NITTO EPTSEALER®

PAGE	No.	PRODUCT NAME
------	-----	--------------

NVH, Waterproofing and Sealing Products

09 p	06	EC-100 Series Flame-retardant NITTO EPTSEALER®
	07	EH-2200 Series Sulfur Less NITTO EPTSEALER®
10 p		Application Examples for NITTO EPTSEALER®
11 p	08	NITTOHARD® Reinforcing Material of Steel/Aluminum Panels
12 p	09	LEGETOLEX Vibration-damping Material

PAGE	No.	PRODUCT NAME
------	-----	--------------

Products for Bonding and Jointing

13 p	10	HYPERJOINT® A Series High Bonding Acrylic Foam Double-coated Tape
	11	HJ-9150W Transparent tape
15 p	12	No. 5015 Multipurpose Double-coated Adhesive Tape
16 p	13	No. 500 Multipurpose Double-coated Adhesive for General Purposes
	14	No. 5011N Flame-retardant Tape
17 p	15	TW-Y01 Double-coated Adhesive Tape for Plastics and Foams
	16	No. 525 For Rough Exterior Surfaces
18 p	17	HF-105S For Fixing Roof Wire Harness to Module Unit
	18	HF-105E Low-VOC for Fixing Roof Wire Harness to Module Unit
19 p	19	VR-5311/VR-5321 For Vulcanized Rubber Applications
	20	VR-5000/VR-5300/VR-5300H Strong-adhesion and Repulsion Resistance Double-coated Adhesive Tape

PAGE	No.	PRODUCT NAME
------	-----	--------------

Products for Surface Protective Materials

20 p	21	No. 440/No. 443/No. 4430 UHMWPE Film and Adhesive Tape
21 p	22	Polyolefin (PO) SPV® Overview

Products for Harness

22 p	23	Low-VOC PVC Tape/Flame-retardant, heat-resistant and High heat-resistant PVC Adhesive Tape Tape for Wire Harness
23 p	24	No. 5/No. 5EG/No. 153/No. 153N/No. 155 Acetate Cloth Adhesive Tape Series
	25	No. 151UL/No. 156A Flame Retardant Acetate Cloth Tape Series
24 p	26	No. 11/No. 15 Butyl Rubber Tape
	27	NF Series Waterproof Insulation Sealing Material

PAGE	No.	PRODUCT NAME
------	-----	--------------

Environment-friendly Products

25 p	28	SCF® Super Clean Foam
26 p	29	No. 512 Low VOC Double-coated Adhesive Tape
27 p	30	No. 5000NS Removable Tape
28 p	31	OW-5016 Double-coated Adhesive Tape for Oily Surface
29 p	32	EW-514/EW-514D/EW-514DB Low-VOC Double-coated Adhesive Tape

PAGE	No.	PRODUCT NAME
------	-----	--------------

Automobile Electronic Products

30 p	33	Heat-resistant Adhesive Tape
31 p	34	TEMISH® High Performance Vent Filter
35 p	35	HT Sheet Thermal Conductive Sheet
36 p	36	ELEP COAT LSS Series Heat-resistant Moisture Proof Coating Material for PCB
	37	NPN/STRATA Series Insulating Paper

PAGE	No.	PRODUCT NAME
------	-----	--------------

37 p Nitto Group Technical Support Centers

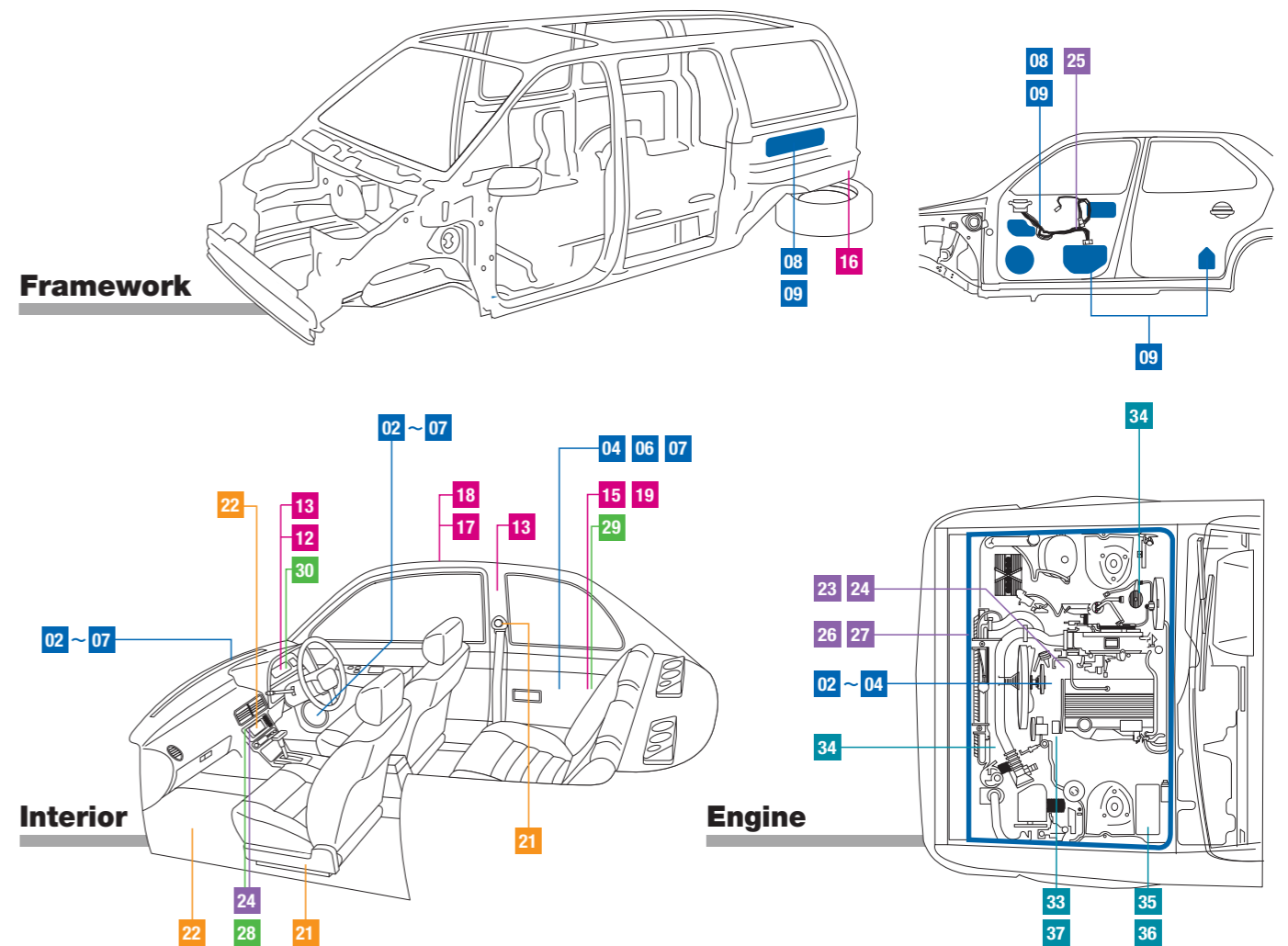
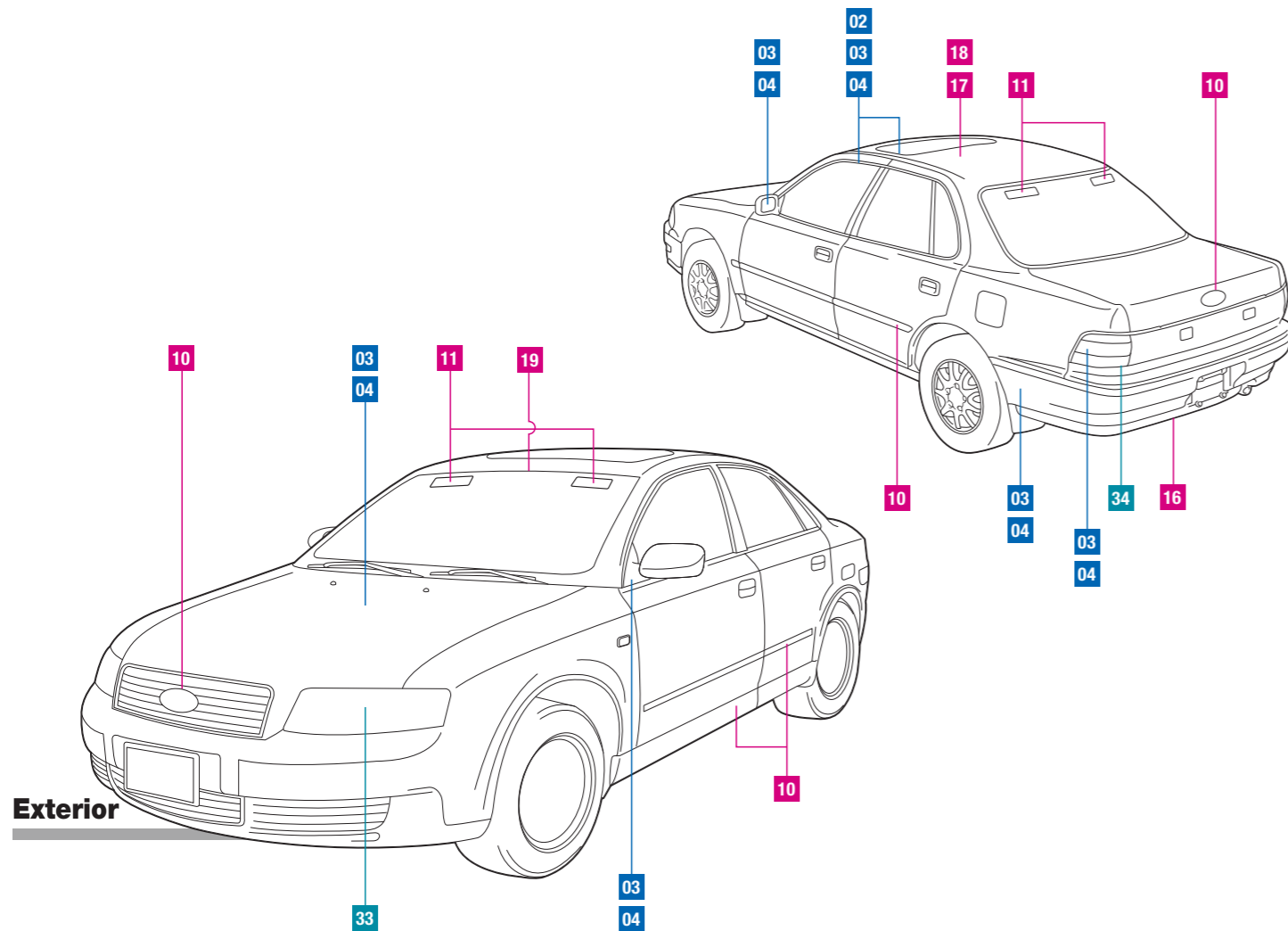



Provision of products and solutions for automobiles and all other sorts of transportation equipment

These days, the meaning of the term “mobility” is undergoing great change.

In this age, we at Nitto provide products and solutions for automobiles and all other sorts of transportation equipment taking

“the environment,” “safety,” “comfort,” and “design” as our key words.

How would you go about joining two things with completely different qualities and forms?

They cannot be linked merely by putting them together.

Between any two things, there is bound to be a gap, however small.

The things to be linked may be iron and plastic, gas and air, or people and objects.

Nevertheless, whatever the gap, it is our job at Nitto to stand in the middle to fill it and generate new value and functions adapted to customer wants and needs.

We are firmly committed to continued contribution to value creation by customers in Green, Clean, and Fine areas, through full application of leading-edge technologies based on polymer synthesis technology.

Nitto Transportation Technical Center (NTTC)

We have established five NTTCs worldwide (Japan, North America, Europe, China and Thailand), providing total solutions to all our customers.

NTTC's Function and Mission

When problems occur with the vibration of outer panels

- To find vibrating sources and understand the vibration state
- To propose products to be selected, locations to be applied and their sizes, etc.

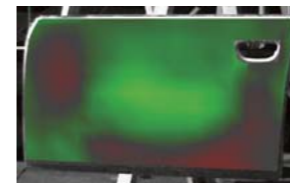

When problems occur with the evaluation of actual items

- To evaluate actual items such as panels based on full scale models
- To reproduce actual heating conditions and propose handling and construction methods

*Some tests may be difficult to perform under actual conditions.



When problems occur with the rigidity of outer panels

- To quantitatively evaluate the current situation
- To examine many different shapes and materials and propose the best conditions

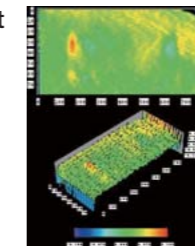

When problems occur with practical evaluation

- To propose additional evaluation results
- To make evaluations and proposals depending on actual usage conditions

Establishment of five NTTCs worldwide (Japan, North America, Europe, China and Thailand)

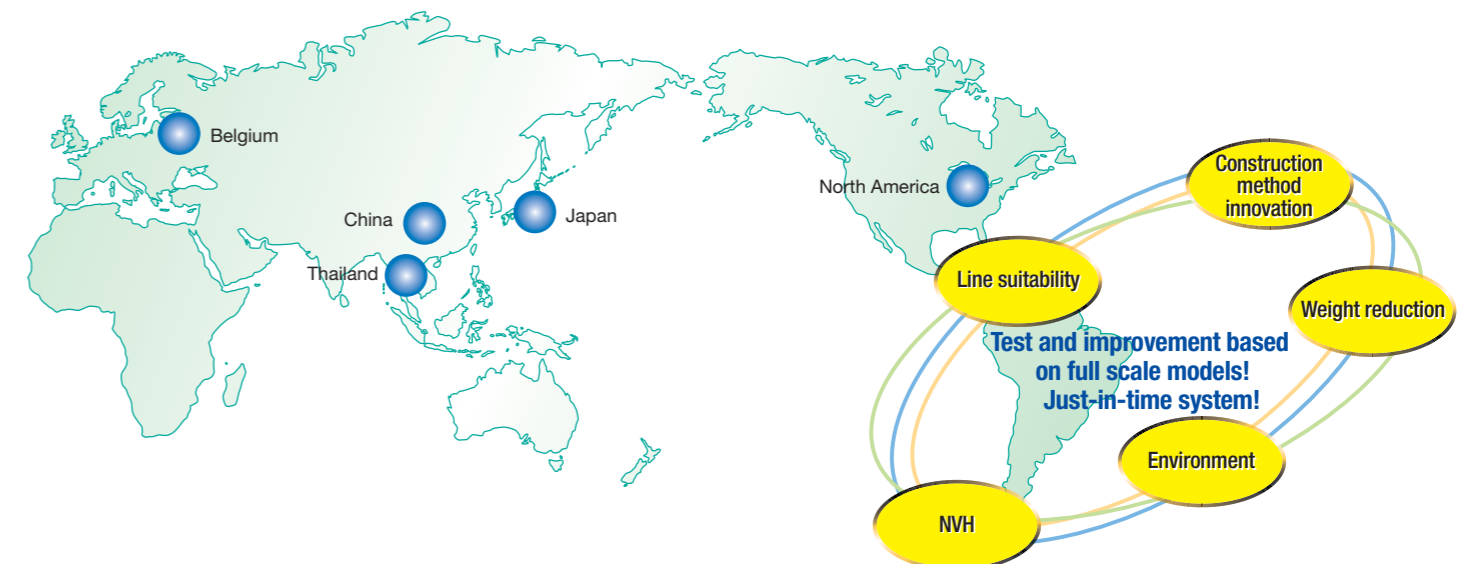

Sealing Material NITTO EPTSEALER®



NITTO EPTSEALER® contributes to enhancing the reliability of products with superior properties.

NITTO EPTSEALER® fills various types of gaps, whether the purpose is to shut out heat, water, sound or vibration, and serves well as a sealing material. Highly functional sealing properties have been developed by blending EPDM rubber foam, which offers the best durability and weather-resistance among general rubber materials, as well as Nitto's unique adhesive technology. Superior resistance to heat and chemicals allows stable and consistent performance over a long period of time. Since NITTO EPTSEALER® is manufactured in four main regions, speedy delivery and stable supply are available worldwide.

Features

- The main constituent is EPDM rubber foam.
- Offers superior durability and resistance to high and low temperatures, weather and chemicals (acids and alkali)*.
- *Compared with general purpose rubber
- Using excellent foam processing technology, Nitto provides foam materials with low density and flexibility.
- Closed and semi-closed cell structures are available, which is only possible with Nitto's foam processing technology.

Structure

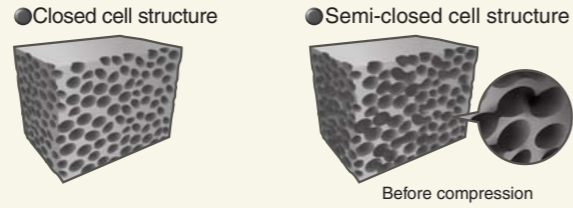

Properties

--- No. 6800 — No. 685 EE-1000

Compression Ratio

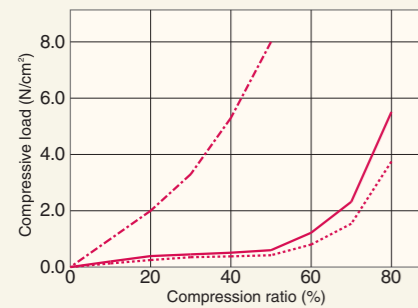

Note: Compression speed: 10mm/min.
 Compression ratio (%) = $\frac{100 \times \text{Pre-compression thickness} - \text{Post-compression thickness}}{\text{Pre-compression thickness}}$
 Each 10cm x 10cm test specimen was compressed at the rate of 10mm/min, until the preset thickness was reached. The compressive load was then measured after a 10 second delay.

Heat Resistance

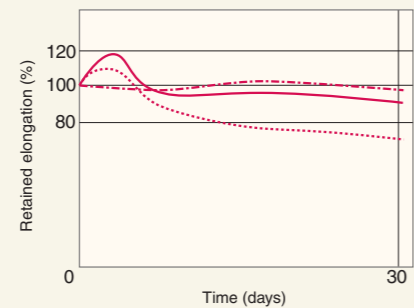

Note: Test specimens prepared using a #1 dumbbell die were exposed to each temperature condition. At the end of each time interval, the test specimens were stretched at the rate of 500mm/min., and the maximum elongation before rupture was measured. Retained elongation was calculated as a percentage of the new specimen's elongation. Measurement temperature: 80°C

Weather Resistance

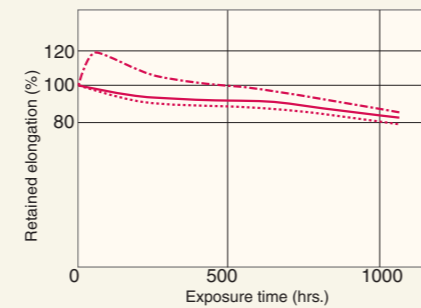

Note: Each test specimen was placed in a sunshine carbon weather meter and taken out after a set time to measure the elongation by stretching at the rate of 500mm/min. Retained elongation was calculated as a percentage of the new specimen's elongation.

Watertightness

Item	Watertightness		
	No. 6800	No. 685	EE-1000
50	○	×	×
60	○	△	×
70	○	○	△
80	○	○	○

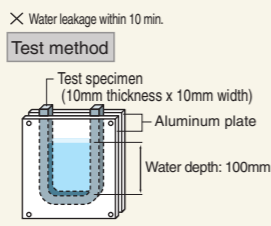

Note: U-shaped 10mm wide test specimens were punched out and placed between acrylic and aluminum plates for compression to a preset load. The test specimens were then filled with water to the depth of 100mm and checked for leakage.

Chemical Resistance

Chemicals	Tensile Strength (N/cm²)		
	No. 6800	No. 685	EE-1000
Initial	35.3	10.8	8.8
Acid (1% H ₂ SO ₄)	30.4	10.3	7.9
Alkali (1% NaOH)	36.3	9.8	7.5

Note: 20°C × 168 hrs. immersion

Comparison of Weather Resistance

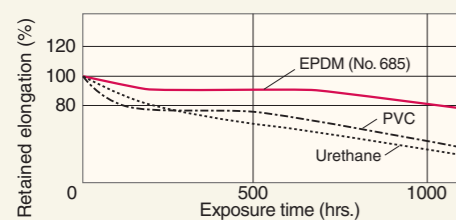

Note: Each test specimen was placed in a sunshine carbon weather meter and taken out after a set time to measure the elongation by stretching at the rate of 500mm/min. Retained elongation was calculated as a percentage of the new specimen's elongation.

Good Balance of General Properties

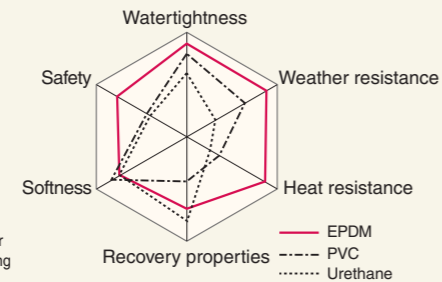

How to Select NITTO EPTSEALER®

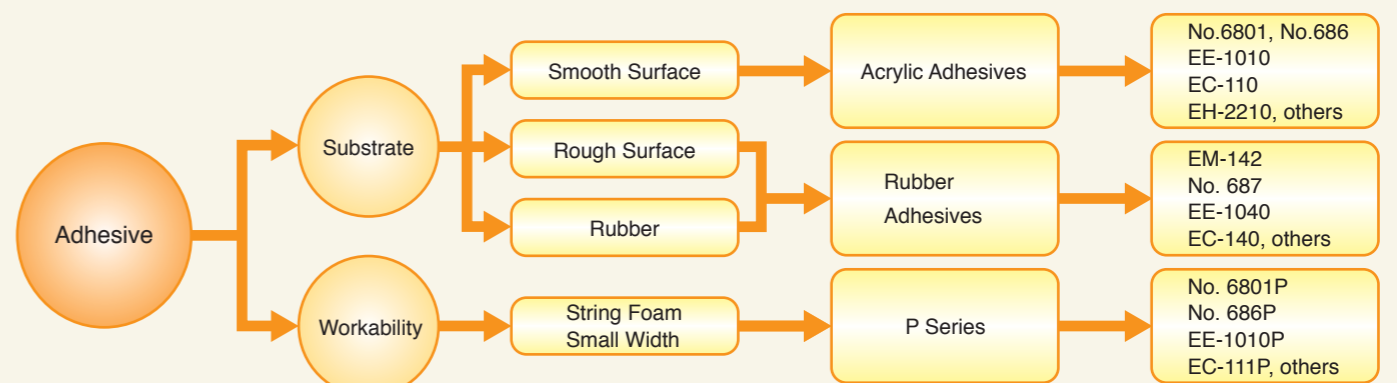
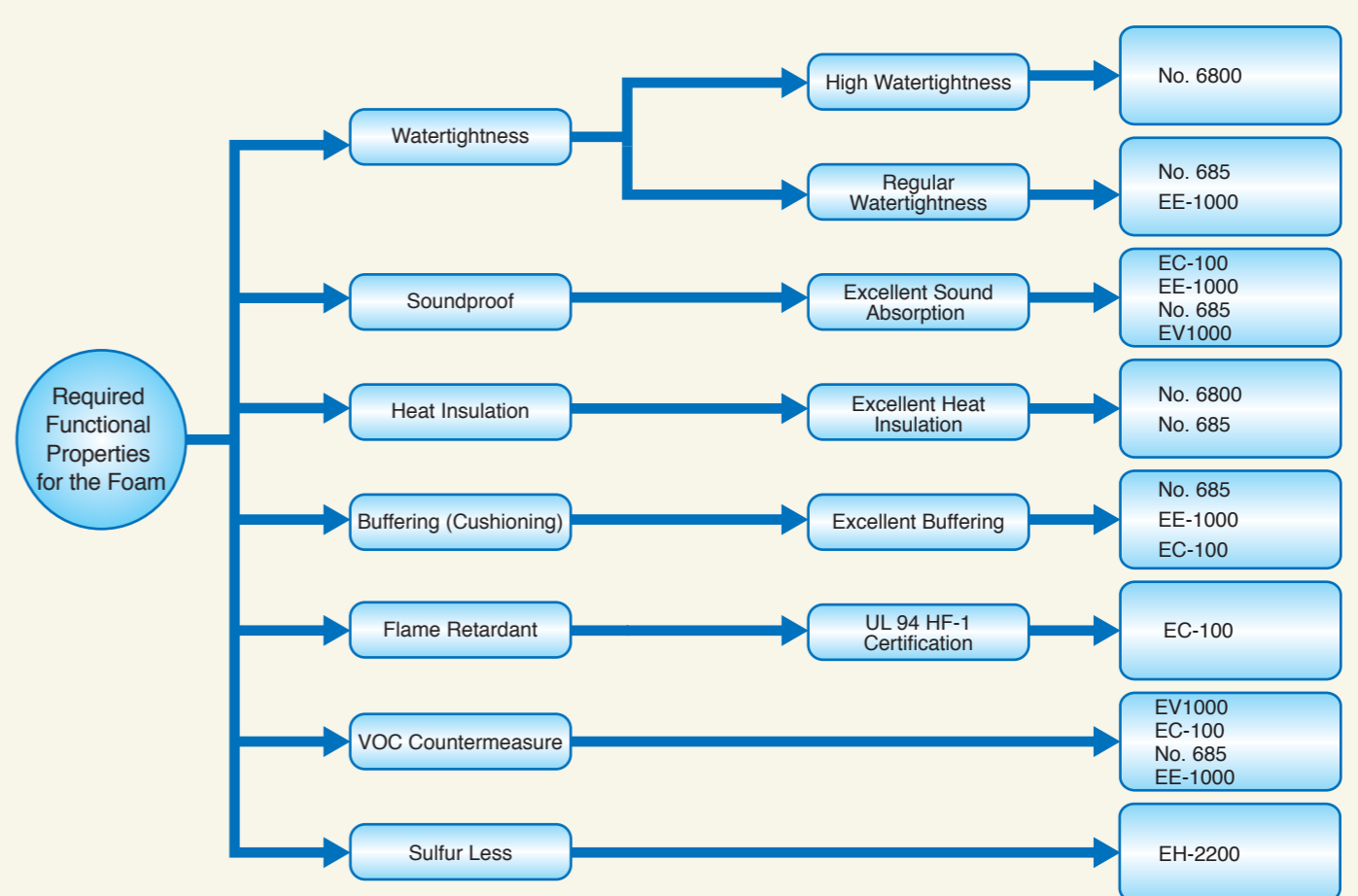

* The measurements for the above foams and adhesives are approximate measures. Please contact us for specific details.
 * Foam layer is certified as flame-retardant

02

NITTO EPTSEALER® No. 6800 Series

Closed cell structure

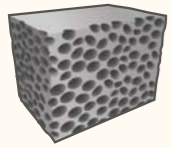

Closed cell structure foam: sealing material with flexibility, elasticity, weather resistance and watertightness

The No. 6800 Series is a high-function foam sealing material consisting of EPDM rubber foam with a closed cell structure, which offers the best durability and weather resistance among general purpose rubbers. The No. 6800 Series offers variations in adhesive tapes, in which you can select between rubber adhesive or acrylic adhesive to best suit your needs.

Features

- Superior weather resistance and watertightness. Offers better heat resistance than foam water sealers such as urethane and polyethylene.
- No. 681 and No. 6801 are coated with an acrylic adhesive and offer superior holding power, heat resistance and weather resistance.
- Closed cell structure offers flexibility and elasticity.
- Can be easily installed in clearances with complicated shapes.

Applications

- Sealing of air conditioner frames
- For objects/areas requiring superior watertightness
- For mounting sunroof

Structure

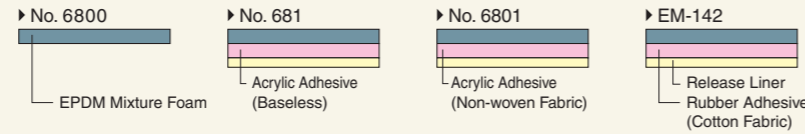

Standard Size

Thickness (mm)	Width (mm)	Length (m)
3-15	1,000	2

Properties

Conforms to JIS K 6767

Product No.	Density (g/cm ³)	Tensile Strength (N/cm ²)	Elongation (%)	Compression Hardness (N/cm ²)	
				25%	50%
No. 6800 Series	0.11	35	240	2.5	8.0

04

NITTO EPTSEALER® EE-1000 Series

Semi-closed cell structure

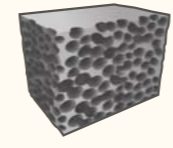

Foam sealing material with superior resistance to cold, heat and chemicals with high weatherability

The EE-1000 Series is a foam sealing material, which consists of EPDM synthetic rubber foam with a semi-closed cell structure for filling the gaps, which are found in various types of equipment. The EE-1000 Series features high-quality foam with a higher degree of foam expansion. Given the specific compression rate for the intended application, the EE-1000 Series is suitable for waterproofing, windproofing, dustproofing, soundproofing and thermal insulation use.

Features

- Low VOC foam as sealing material.
- Offers superior durability and resistance to weather, cold and heat (-20 to 100°C), and chemicals (acids and alkalis).
- Compression load (stress) is slight, so structure is not deformed after mounting objects with foam sealer.
- Flexible material is easy to use when compressed.
- Low apparent density of 0.11; foam pieces do not fuse together.

Applications

- Waterproofing, air sealing, soundproofing and thermal insulation for air conditioners and air cleaners
- Mounting of cowl louvers, door mirrors and center pillar garnish

Structure

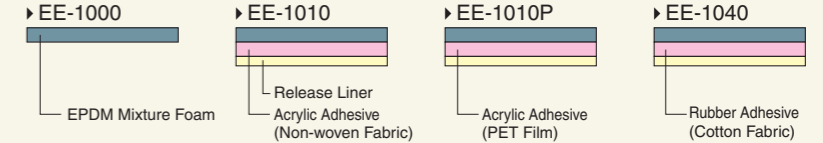

Standard Size

Thickness (mm)	Width (mm)	Length (m)
3-20 (with adhesive: 3-25mm)	1,000	2

Properties

Conforms to JIS K 6767

Product No.	Density (g/cm ³)	Tensile Strength (N/cm ²)	Elongation (%)	Compression Hardness (N/cm ²)	
				25%	50%
EE-1000 Series	0.11	8.0	450	0.33	0.45

03

NITTO EPTSEALER® No. 685 Series

Semi-closed cell structure

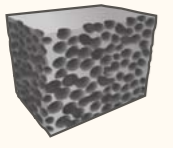

Semi-closed cell structure foam: sealing material with flexibility, elasticity, weather resistance and watertightness

The No. 685 Series is a high-function foam sealing material, which consists of EPDM rubber foam with a semi-closed cell structure. EPDM rubber offers the best durability and weather resistance as rubber used for general purposes. Made of a flexible material, the No. 685 Series is easy to compress, and thus offers superior watertightness and airtightness. The series offers a selection of various adhesive tape materials from rubber to acrylic to meet customers' needs.

Features

- Low VOC foam as sealing material.
- Offers superior durability and resistance to weather, cold and heat (-20 to 100°C), and chemicals (acids and alkalis).
- Compression load (stress) is slight, so structure is not deformed after foam filling.
- Flexible material is easy to use when compressed.
- Low apparent density of 0.13; foam pieces do not fuse together.

*VOC (Volatile Organic Compounds)

Applications

- Sealing of air conditioner ducts
- For objects/areas requiring superior watertightness
- For instrumental panel and front windshield mounting
- For mounting of door mirrors and center pillar

Structure

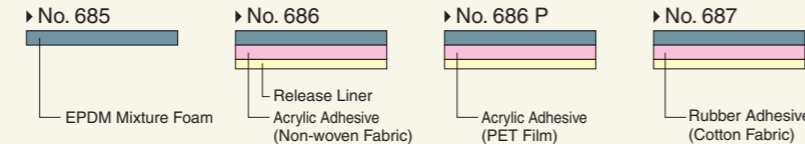

Standard Size

Thickness (mm)	Width (mm)	Length (m)
3-35 (with adhesive: 3-40mm)	1,000	2

Properties

Conforms to JIS K 6767

Product No.	Density (g/cm ³)	Tensile Strength (N/cm ²)	Elongation (%)	Compression Hardness (N/cm ²)	
				25%	50%
No. 685 Series	0.13	10	550	0.39	0.60

05

NITTO EPTSEALER® EV1000 Series

Semi-closed cell structure

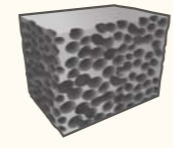

EV1000 Series uses low VOC foam as a sealing material

The EV1000 Series features low VOC. Composed of a flexible foam sealing material, it consists of EPDM rubber foam with a semi-closed cell structure. The series offers a selection of various adhesive tape materials from butyl rubber to acrylic. Given the specific compression rate for the intended application, the EV1000 Series is effective for waterproofing, air sealing, soundproofing and insulation use.

Features

- Low VOC foam as sealing material.
- Easily compressed with minimal pressure; allows a snug fit even to uneven complex surfaces and further enhances air sealing and soundproofing.
- Superior heat, weather, and ozone resistance enables the foam to withstand long-term use.

*VOC (Volatile Organic Compounds)

Applications

- Waterproofing, air sealing, soundproofing, dustproofing and thermal insulation for interior and exterior of automobile parts, and for air conditioners

Structure

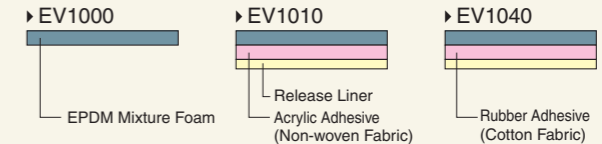

Standard Size

Thickness (mm)	Width (mm)	Length (m)
3-30 (with adhesive: 3-35mm)	1,000	2

Properties

Conforms to JIS K 6767

Product No.	Density (g/cm ³)	Tensile Strength (N/cm ²)	Elongation (%)	Compression Hardness (N/cm ²)	
				25%	50%
EV1000 Series	0.07	5.0	400	0.23	0.35

Flame-retardant NITTO EPTSEALER® EC-100 Series

Semi-closed cell structure

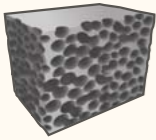

Sealant containing a flame retarder is UL-94 HF-1 certified.

Products of the Nitto EC-100 Series which have obtained UL-94 HF-1 certification are composed of a flexible foam sealing material consisting of EPDM rubber foam with a semi-closed cell structure mixed with a flame retarder. Various types with adhesive layers are available, all of which take advantage of their flexible foam properties. The products can be used for waterproofing, airtightness, soundproofing, or thermal insulation according to the compression ratio.

Features

- Containing chlorine-free flame retarder, EC-100 series has obtained UL-94 HF-1 certification, the most stringent standard for flame retardancy of foam.
- Minimal stress facilitates compression; fits snugly to uneven surfaces thereby enabling airtight sealing and soundproofing.
- Superior heat, weather, and ozone resistance enables the foam to withstand long-term use.

Applications

- Waterproofing, air sealing, soundproofing and thermal insulation for electric/electronic equipment

Structure



Standard Size

Thickness (mm)	Width (mm)	Length (m)
3-20 (with adhesive: 3-25mm)	1,000	2

Properties

Conforms to JIS K 6767

Product No.	Density (g/cm ³)	Tensile Strength (N/cm ²)	Elongation (%)	Compression Hardness (N/cm ²)	
				25%	50%
EC-100 Series	0.085	7.0	270	0.18	0.28

Sulfur Less NITTO EPTSEALER® EH-2200 Series

Semi-closed cell structure

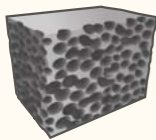

Foam sealing material with excellent resistance to metal corrosion

NITTO EPTSEALER® EH-2200 Series are semi-closed cell structure EPDM rubber foam materials with or without adhesive which can be used as buffer, dustproof, soundproof, or thermal insulation according to the compression ratio.

Features

- Since sulfur is not used, it excel in resistance to metal corrosion.
- Since compression load is low, it does not deform the structure after application.
- Be excellent at durability, weather-resistance, heat-resistance, and chemical resistance.
- Foam layer (EH-2200) is UL-94HBF certified.

Applications

- Buffer and insulation material for FTV speaker.
- Sealing material for around ECU.
- Sealing material for around Li-ion battery.
- Sealing material for other electric equipments and electronic devices.

Structure

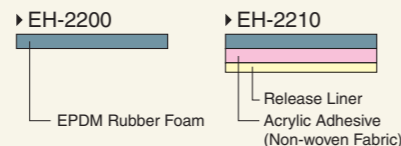

Standard Size

Thickness (mm)	Width (mm)	Length (m)
3-20 (with adhesive: 3-20mm)	900	2

Properties

Conforms to JIS K 6767

Product No.	Density (g/cm ³)	Tensile Strength (N/cm ²)	Elongation (%)	Compression Hardness (N/cm ²)	
				50%	80%
EH-2200 Series	0.11	6.0	270	0.22	1.30

Application Examples for NITTO EPTSEALER® (Exterior)

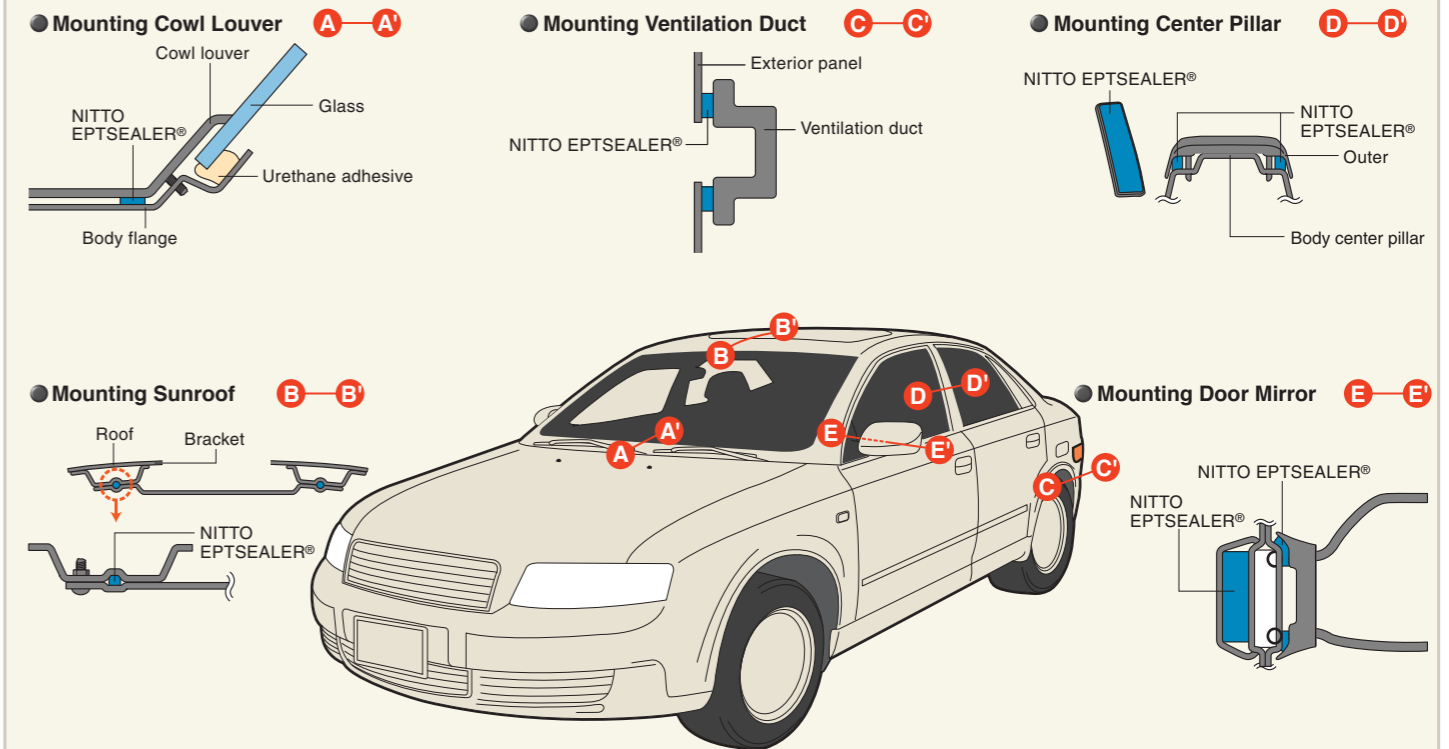

Application Examples for NITTO EPTSEALER® (Interior)

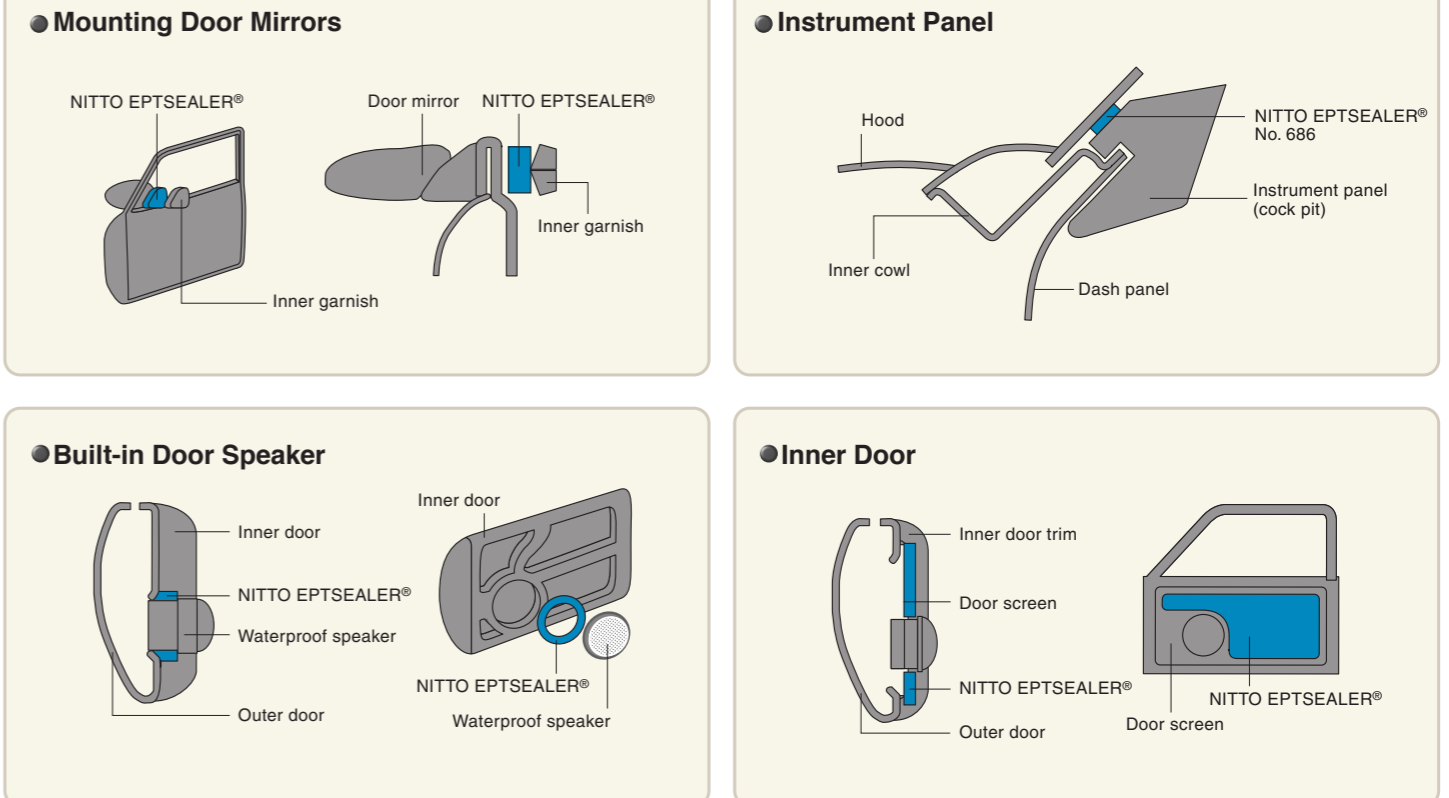

Reinforcing Material of Steel/Aluminum Panels NITOHARD®



Expandable reinforcing material adheres firmly to steel/aluminum panels, including curved surfaces

As body panels become even thinner, such problems as a decline in rigidity and increased noise generation arise. One solution to these problems is NITOHARD®, an epoxy/a synthetic rubber foam type reinforcing and material for steel/aluminum panels developed using Nitto's proprietary polymer technology. This product firmly adheres to steel/aluminum panels and conforms to curved surfaces. NITOHARD® is foamed and hardened using the heat in paint-drying process lines, and provides partial reinforcement of steel/aluminum panels.

Features

- Can be easily attached to steel/aluminum panels. Formed and hardened by heating while still attached to provide excellent reinforcement, soundproofing and thermal insulation.
- Initial adhesive property permits easy attachment to a variety of materials. Can also be attached without pre-processing to oily steel/aluminum panels.
- Remains flexible before foaming and adheres tightly to complex shapes and curved surfaces. Extremely easy to work with; has excellent punchability.
- Wide functional temperature range; does not deteriorate at low or high temperatures.
- Special structure of resin layer prevents strain of substrate after hardening.
- Responds to the trend toward local procurement for global production.

Structure

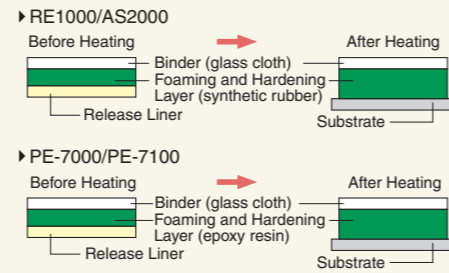

Properties

Product No.	Type	Foaming Ratio	Remarks
RE1000	Large area	2.5 times	Excellent adhesion and workability at low temperatures
PE-7000	Standard	2 times	Can be used in a variety of applications
PE-7100	High-foaming	3 times	Significant weight reduction
AS2000	High-foaming	3 times	Can be used for aluminum panel

These materials foam by heating. Please contact our sales representative for storage conditions or other information.

Effect of Using NITOHARD®

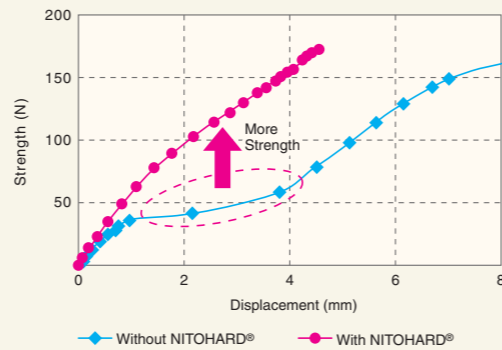

Distortion Measurement Analysis Technologies

- Enables distortion evaluation before in-vehicle confirmation, thereby reducing the number of trial production man hours.
- Allows for optimal design that considers distortions in accordance with the location of the area used and the thickness of the steel/aluminum panel.
- Enables quantification of actual distortions that arise.
- Enables confirmation of location and shape of distortions on a PC screen.

Measurement of distortion through laser displacement shaping



ALASKA* distortion measurement analyzer
*ALASKA: Automatic Large-size Sink Mark Analyzer

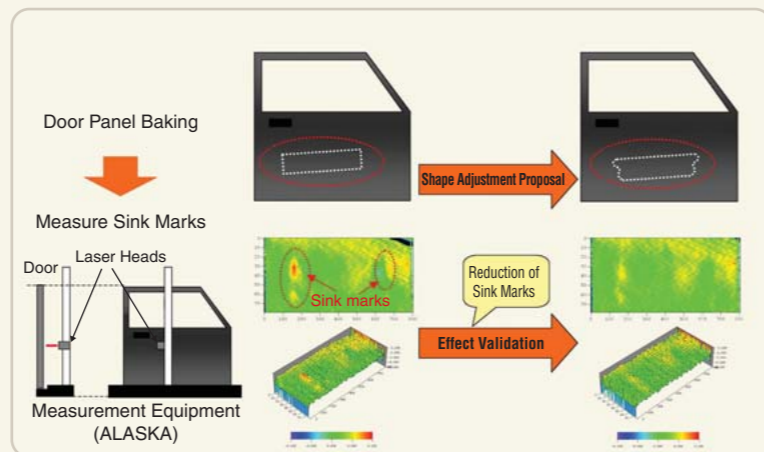

Vibration-damping Material LEGETOLEX



Lightweight, high-function, vibration-damping material based on proprietary technologies in adhesives and soundproofing evaluation and design

This lightweight, vibration-damping material weighs less than conventional damping materials, is less dependent on temperature and exhibits a stable damping effect at a wide range of temperatures. This adhesive material doesn't require further adhesive, adheres well to rough or oily surfaces and smoothly follows the contour of three-dimensional curved surfaces. Applying the damping material to only approximately 30% of the panel area provides a significant reduction in noise. In addition to the aluminium standard type (D-300N), glass-cloth type

Features

- Offers reliable vibration damping for a wide range of temperatures.
- Low specific gravity contributes to lighter weight.
- Because this is a pressure-attached adhesive, there is no need for spreading adhesives or for heat treatment.
- Responds to the trend toward local procurement for global production.

Structure



Standard Size

Product No.	Thickness (mm)	Specific Gravity	Product Weight (kg/m²)
D-300N	1.5	1.4	2.1
D-350	2.2	1.3	2.9

Properties

Relationship Between Mounting Area and Noise Reduction

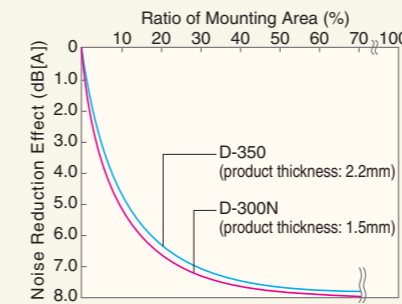

- Notes: ● Noise reduction effect = (noise level before mounting damping material) - (noise level after mounting damping material)
 ● Ratio of damping material area indicates ratio of damping material mounting area to 400mm x 400mm steel panel

Initial Adhesive Strength (Substrate: Stainless Steel Panel)

Product No.	Ambient Temperature		
	0°C	20°C	40°C
D-300N	91.4	59.4	22.1
D-350	95.3	68.8	24.4

Note: Evaluation method: 90°C peeling test

Vibration Analysis Technologies

Laser Vibrometer Analysis

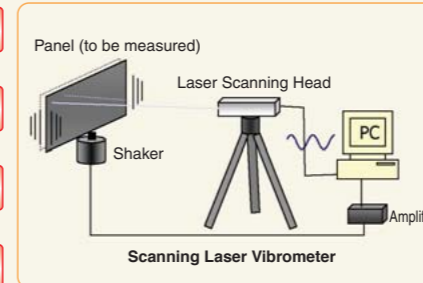
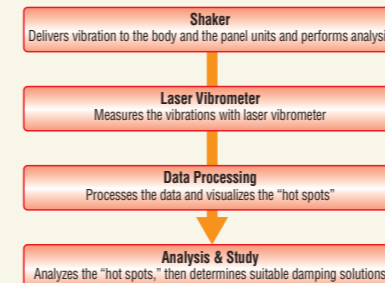

Sample Study

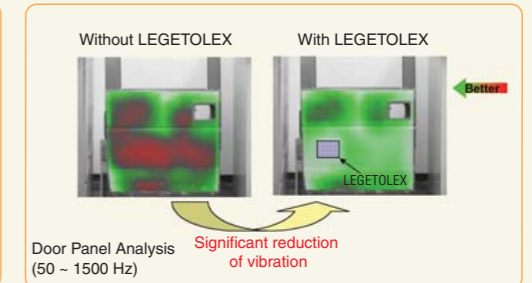

10 High Bonding Acrylic Foam Double-coated Tape HYPERJOINT® A Series



Double-coated adhesive tapes for automobile exteriors

HYPERJOINT is a double-coated adhesive tape for attaching automobile exterior components. Extremely flexible acrylic foam and base material with excellent durability are used, enabling high performance in terms of adhesive strength, heat resistance and durability. In addition to a standard type of release liner, polyester film release liner and light release liner are also available. *Please consult our sales representatives for further details.

Features

- Extremely high adhesive strength with excellent heat and water resistance.
- The highly flexible acrylic foam carrier complies with the expansion and contraction of the adherend, maintaining stable adhesiveness.

Structure

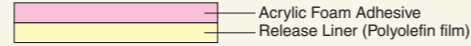

Standard Size

A4000-R Series (Hi Soft Type)

A4000-R Series products conform well to corrugated surfaces, ensuring a wide adhesive area

Product No.	Standard Size		
	Adhesive Thickness (mm)	Liner Color	Color (core)
A4002-R	0.2	Blue	White
A4004-R	0.4	Blue	Light Blue
A4006-R	0.6	Blue	Marine Blue
A4008-R	0.8	Blue	White
A4010-R	1.0	Blue	Light Blue
A4012-R	1.2	Blue	Marine Blue
A4016-R	1.6	Blue	Light Blue

A3000-R Series (Soft Type)

A3000-R Series products exhibit good balance between adhesion and retention properties

Product No.	Standard Size		
	Adhesive Thickness (mm)	Liner Color	Color (core)
A3002-R	0.2	Green	White
A3004-R	0.4	Green	Light Blue
A3006-R	0.6	Green	Marine Blue
A3008-R	0.8	Green	White
A3010-R	1.0	Green	Light Blue
A3012-R	1.2	Green	Marine Blue
A3016-R	1.6	Green	Light Blue
A3020-R	2.0	Green	White

Properties

180° Peeling Force

Adherend/painted board: clear painted board (acid rain resistant paint + water-based paint)

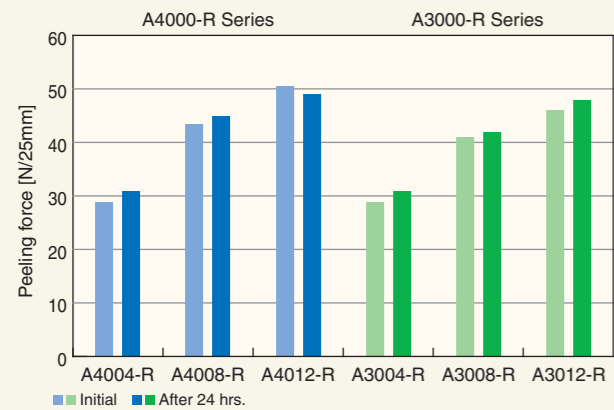

*Peel speed: 50mm/min

Shear Strength

Adherend/painted board (same as on the left) × chrome board (chrome-plated board for emblem)

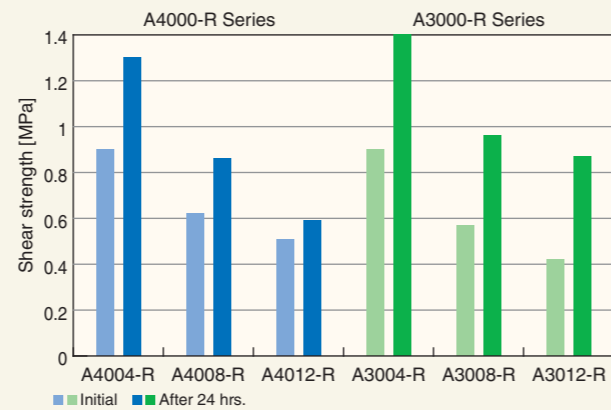

*Peel speed: 50mm/min

Applications

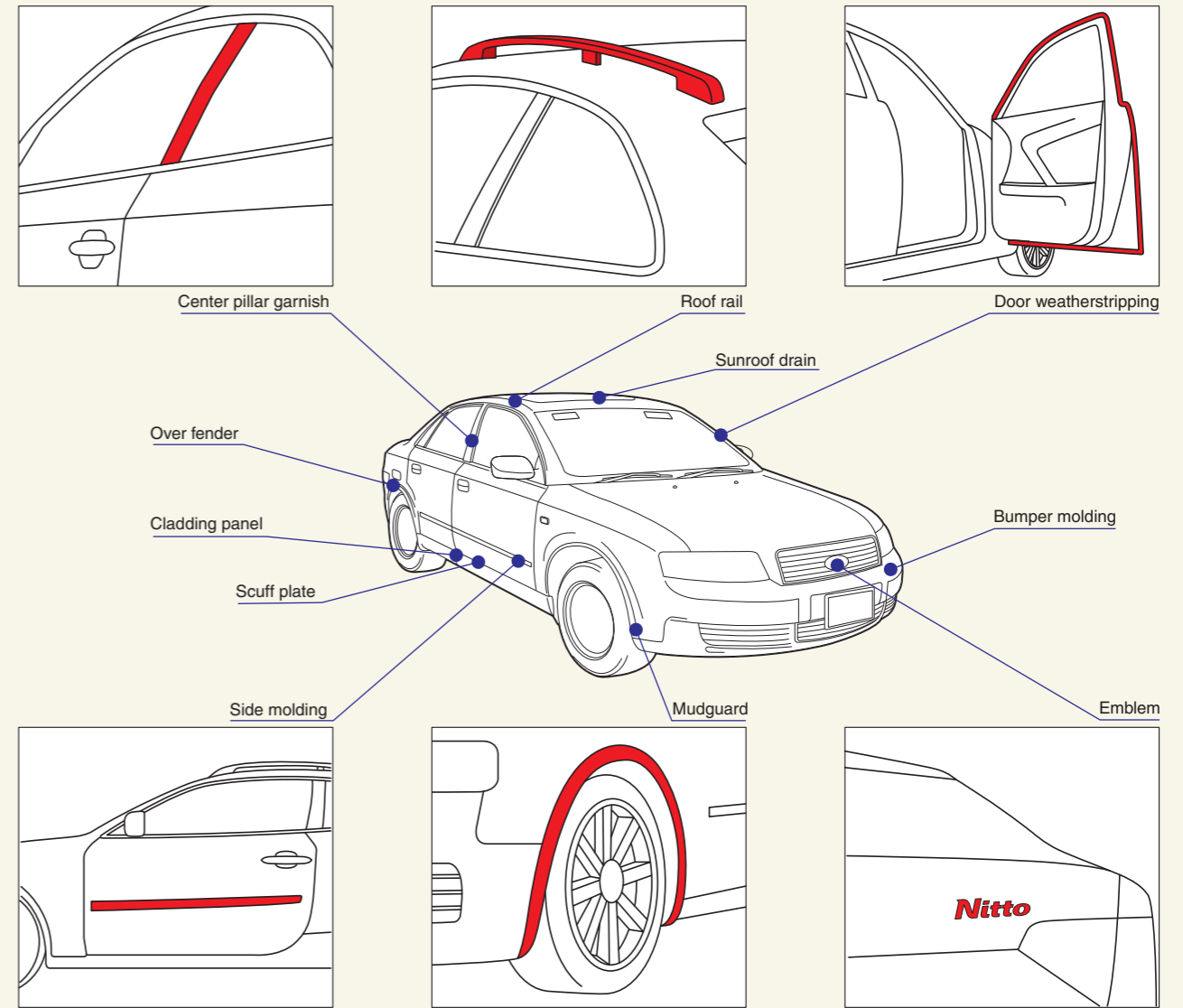

Pick Off Tape (for Picking up Release Liner)

- Strong adhesion to HYPERJOINT release liner (polyolefin film) and easy peeling
- Pick off tape uses strong carrier, is easy to grip and contributes to work efficiency



Manufacturer: Nitoms, Inc.



*It is advisable to use a primer depending on substrates.
*If you have any questions about pick off tape specifications or primer, please contact our sales representatives.

11 Transparent Tape HJ-9150W



Non-carrier double-coated adhesive tape with excellent transparency

HJ-9150W is a non-carrier double-coated adhesive tape that is clean and transparent. The tape has a strong adhesion with ultra thin adhesive. Offers superior bonding for automotive diversity antennas.

Features

- Offers superior transparency.
- Appearance is not damaged, even when used in places exposed to sunlight or high temperatures/humidity.
- Ideal for application to plastics such as polycarbonate.
- Offers strong adhesion, easy processing, user friendliness and produces minimal volatile gas.

Structure

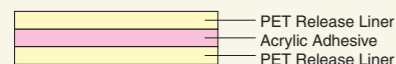

Applications

- Bonding of glass
- Application of optical film to display panel surfaces
- Film tape for automobile diversity antennas



Standard Size

Product No.	Tape Thickness (mm)	Width (mm)	Length (m)
HJ-9150W	0.05	20-500	50

Properties

180° Peeling Force

Substrate	180° Peeling Force (N/20mm)
Acrylic Plate	11.3
Glass Plate	9.8
Polycarbonate Plate	7.9
PET Plate	7.4
Stainless Steel Plate	10.8
Aluminum Plate	8.3

*Measured by peeling in a 180° direction at a speed of 300mm/min at 23°C with polyester film 0.025mm lining.

Weather Resistance

Product No.	Aging Time
HJ-9150W	3000hrs.

○ Good appearance with no color change
Note: Tape is sandwiched between PET release liners and then placed in a sunshine carbon weather meter. The specimen is removed after the prescribed amount of time and then assessed by viewing the appearance.

Humidity and Heat Resistance

Product No.	Aging Time
HJ-9150W	1000hrs.

○ Good appearance with no color change
Note: Tape is applied to glass slides and then placed in an 80°C, 90% RH atmosphere. The specimen is removed after the prescribed amount of time and then assessed by viewing the appearance.

13 Multipurpose Double-coated Adhesive Tape for General Purposes No. 500



Popular general purpose double-coated adhesive tape

Nitto's most popular double-coated adhesive tape for multiple use consists of flexible nonwoven fabric impregnated with pressure-sensitive adhesive. Superior adhesive strength makes the tape ideal for general bonding.

Features

- Offers excellent adhesive strength for nameplates, metal plates, etc.
- Offers better repellency than other double-coated adhesive tapes and prevents separation from the substrate to which it is applied.
- Can be widely used as an industrial double-coated adhesive tape.
- Line-up includes No. 500AB with a black adhesive.

Structure

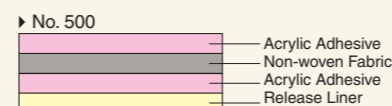

Standard Size

Carrier	Tape Thickness (mm)	Width (mm)	Length (m)
Non-woven Fabric	0.17	3-1,200	50

Applications

- Fixing of punched metal nameplates
- Fixing of garnish for automobile meter panels, air conditioners, etc.
- Fixing of ABS decorative panels
- Fixing of plastic display panels

Properties

180° Peeling Force (for each substrate) (N/20mm)

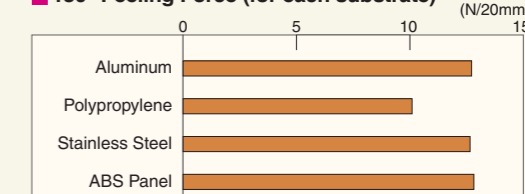

*Measured by peeling in a 180° direction at a speed of 300mm/min at 23°C with polyester film 0.025mm lining.

12 Multipurpose Double-coated Adhesive Tape No. 5015

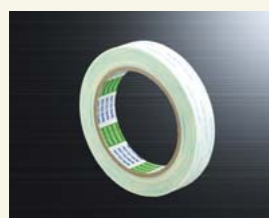

Strong double-coated adhesive tape for fixing interior materials and nameplates

No. 5015 consists of flexible nonwoven fabric, which is impregnated with powerful pressure-sensitive adhesive. Stable adhesive strength can be expected for metals and various types of plastics such as polyethylene and polypropylene. No. 5015 is able to provide stable fixing of nameplates and foam due to its good repellency that enables a small amount of force to be applied continuously.

Features

- Offers stable adhesive strength for various materials including metal and plastic.
- Offers superior adhesive strength for temperatures ranging from low to high.
- Maintains stable fixing even in environments where a small amount of force is constantly applied.

Structure

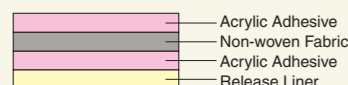

Standard Size

Carrier	Tape Thickness (mm)	Width (mm)	Length (m)
Non-woven Fabric	0.12	3-1,200	50

Applications

- Fixing of interior materials
- Fixing of various types of nameplates
- Fixing of car air conditioner insulation materials

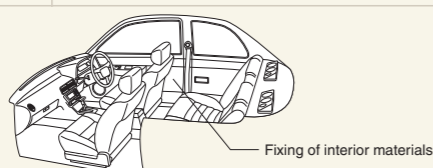

Properties

180° Peeling Force (for each substrate)

Substrate	Peeling Force (N/20mm)
Stainless steel	16.0
Aluminum	15.5
PP	12.5
PC	13.5
ABS	13.5
PVC	16.0
PST	13.5
POM	10.0

180° Peeling Force (for each temperature)

Substrate	Temperature	Peeling Force (N/20mm)
Stainless steel	0°C	21.0
	23°C	16.0
	40°C	13.0
	60°C	12.0
	80°C	10.5

14 Flame-retardant Tape No. 5011N



Double-coated adhesive tape conforms to flame retardancy standards

No. 5011N flame-retardant double-coated adhesive tape is UL-94 VTM-0 certified.

Features

- Offers superior initial adhesive strength and is easy to work with at low temperatures.
- Adheres easily to various types of substrates.
- Adheres well to surfaces ranging from smooth to rough.
- Complies with UL-94 VTM-0 standards for flame retardancy (File No. E52859 [M]).

Structure

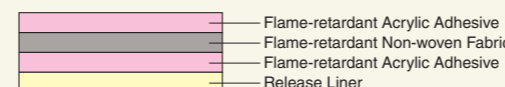

Standard Size

Carrier	Tape Thickness (mm)	Width (mm)	Length (m)
Non-woven Fabric	0.15	3-1,200	50

Applications

- Fixing of components for electrical and electronic equipment
- Interior materials for automobiles
- Application of flame-retardant materials

Properties

Product No.	180° Peeling Force (N/20mm) (For stainless steel)
No. 5011N	14.3

*Measured by peeling in a 180° direction at a speed of 300mm/min at 23°C with polyester film 0.025mm lining.

15

Double-coated Adhesive Tape for Plastics and Foams TW-Y01



Offers superior repellency, adheres well to rough surfaces such as foam.

TW-Y01 consists of flexible nonwoven fabric impregnated with pressure-sensitive adhesive. The tape can be easily applied to plastics such as polypropylene and the rough surfaces of foams.

Features

- Easily applied to rough surfaces such as foam and plastic materials such as polypropylene.
- Excellent repellency

Structure

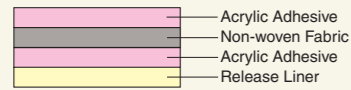

Standard Size

Carrier	Tape Thickness (mm)	Width (mm)	Length (m)
Non-woven Fabric	0.17	3-1,200	50

Properties

Product No.	180° Peeling Force (N/20mm) (For stainless steel)
TW-Y01	15.2

*Measured by peeling in a 180° direction at a speed of 300mm/min at 23°C with polyester film 0.025mm lining.

Applications

- For bonding plastics and foams

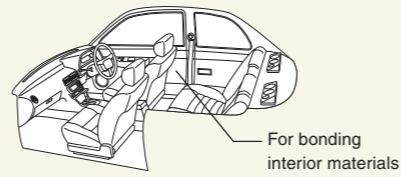

17

For Fixing Roof Wire Harness to Module Unit HF-105S

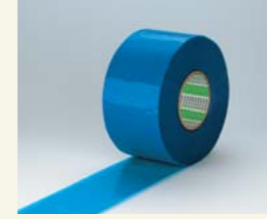

HF-105S adheres firmly to the roof head lining and other rough surfaces. This single-coated tape offers superior initial and low-temperature adhesiveness.

HF-105S also adheres firmly to rough surfaces, offering superior initial adhesion at low temperatures. This tape offers good workability as an adhesive tape for automobile roof applications.

Features

- HF-105S is a single-coated adhesive tape, and the base is polyolefin film. HF-105S is designed for partial bonding of roof modules.

Structure

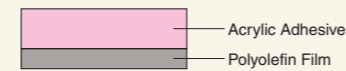

Standard Size

Carrier	Tape Thickness (mm)
Polyolefin film	0.23

Applications

- Fixing of roof wire harness to module unit

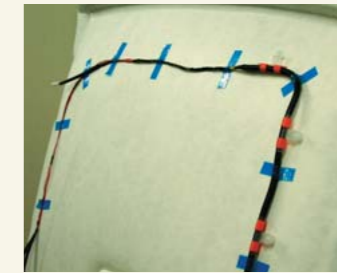

16

For Rough Exterior Surfaces No. 525



Double-coated adhesive tape for rough surfaces, which is not affected by weather changes

No. 525 is a double-coated adhesive tape, which is thickly coated with a special synthetic rubber adhesive on both sides of its carrier. Adheres snugly to rough surfaces and is widely used for temporary fixing of automobile parts and panels.

Features

- Excellent weather resistance; its properties are not affected by weather changes.
- Thick adhesive adheres well to rough surfaces.

Structure

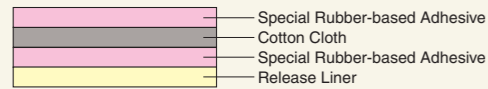

Standard Size

Carrier	Tape Thickness (mm)
Cotton Cloth	0.5/1.0

Properties

Product No.	180° Peeling Force (N/20mm) (For stainless steel)
No. 525	42.4

*Measured by peeling in a 180° direction at a speed of 300mm/min at 23°C with polyester film 0.025mm lining.

Applications

- Waterproofing of weather stripping
- Fixing of trunk side trim
- Fixing of fuel tank pads



18

Low-VOC for Fixing Roof Wire Harness to Module Unit HF-105E

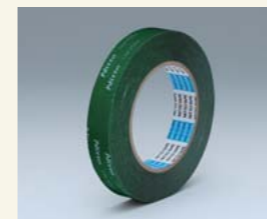

HF-105E adheres firmly to the roof head lining and other rough surfaces. This single-coated tape offers superior initial and low-temperature adhesiveness.

HF-105E also adheres firmly to rough surfaces, offering superior initial adhesion at low temperatures. This tape offers good workability as an adhesive tape for automobile roof applications. Awarded the 46th "Environmental Award" in Japan.

Features

- Excellent adhesion to rough surface (foam, non-woven fabric, felt).
- By using a flexible PP carrier, it has good followability and is also hand-cut.
- Use no organic solvents (toluene, xylene, ethyl acetate, etc.)
- The guideline values for the 13 VOCs specified by Japan's Ministry of Health, Labour and Welfare are satisfied.

Structure

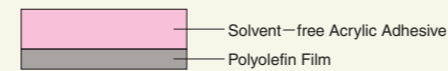

Standard Size

Carrier	Tape Thickness (mm)
Polyolefin film	0.14

Applications

- Fixing of roof wire harness to module unit
- Good workability due to hand cutting



19 For Vulcanized Rubber Applications VR-5311 (Strong Holding Power)/ VR-5321 (Strong Initial Adhesion)

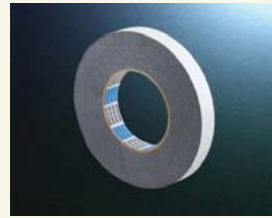

Excellent adhesion for bonding vulcanized rubber sheets. Adheres well without a primer

Nitto's double-coated adhesive tape consists of a PET film carrier with rubber adhesive on one side and acrylic adhesive on the other side. Ideal for binding rubber with metal or plastic.

Features

- Offers superior adhesive strength without treating the surface with a primer, etc.
- Offers excellent adhesion to various types of rubber including chloroprene, EPT and natural rubber.

Note: Does not adhere well to some types of rubber. Test before attempting to put to practical use.

Standard Size

Tape Thickness (mm)	Width (mm)	Length (m)
0.15	3-1,200	50

Structure

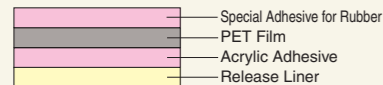

Applications

- Fixing of rubber dams
- For vulcanized rubber cushions
- Temporary fixing or bonding of packing materials
- Fixing of cushioning such as rubber plates or foam; fixing of rubber legs

Properties

Rubber Surface Treatment Method and 180° Peeling Force

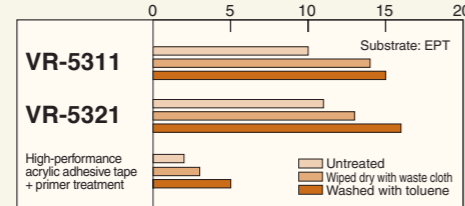

180° Peeling Force for Each Type of Rubber

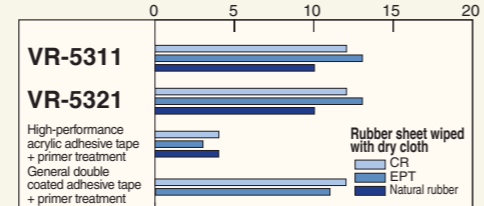

*Measured by peeling in a 180° direction at a speed of 300mm/min at 23°C with polyester film 0.025mm lining.

20 Strong-adhesion and Repulsion Resistance Double-coated Adhesive Tape VR-5000/VR-5300/VR-5300H



VR-5000/VR-5300/VR-5300H series products also conform well to curved surfaces.

These double-coated adhesive tapes use a special rubber adhesive and exhibit excellent adhesion to many different substrates. These tapes can be widely used to bond curved surfaces of metal or plastic substrates and for fixing foam or rubber materials.

Features

- Neither lifting nor peeling-off for curved surfaces.
- Used for every substrate.

Structure



Standard Size

Tape Thickness (mm)	Width (mm)	Length (m)
0.14	5-1,200	50

Applications

- For super-strong fixation of parts and components
- For fixing items to curved surfaces or resilient parts

Properties

180° Peel Adhesion Test Results by Substrate Type



21 UHMWPE Film and Adhesive Tape No. 440/No. 443/No. 4430

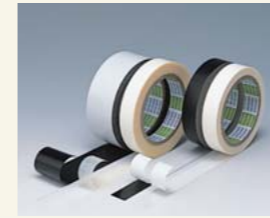

Film and adhesive tapes with excellent capacities including impact and abrasion resistance, and self-lubrication

No. 440 is UHMWPE (Ultra-High-Molecular-Weight Polyethylene) film. No. 443 and No. 4430 are adhesive tapes in which the base material No. 440 (UHMWPE film) is coated with pressure sensitive adhesive and has a release liner. No. 443 and No. 4430 offer excellent abrasion resistance, and sliding property, compared to adhesive tapes made of other plastic films.

Features

- Excellent sliding property properties.
- Chemical resistance is stable, apart from some strong concentrated inorganic acids and aromatic solvents.
- Excellent non-water absorbing and nonhygroscopic properties.
- No. 4430 displays excellent adhesion between the base and adhesive.

Applications

- For vibration of revolving seats in one-box cars (vans)
- For eliminating vibration noise of smart keys
- In spaces of such vehicle components as automobile lamps
- For sliding of sunroofs
- For thrust washers in motors

Structure

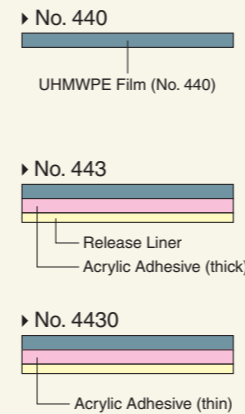

Standard Size

Substrate Thickness (mm)*	Width (mm)	Length (m)	Color
0.1	300/350	10/30	White/Black
0.13			
0.2			
0.25			
0.3			
0.4			
0.5			
0.8			
1.0			

*The thickness of No.4430 are 0.13mm, 0.2mm and 0.25mm only.

Properties

Friction and Abrasion Properties of UHMWPE

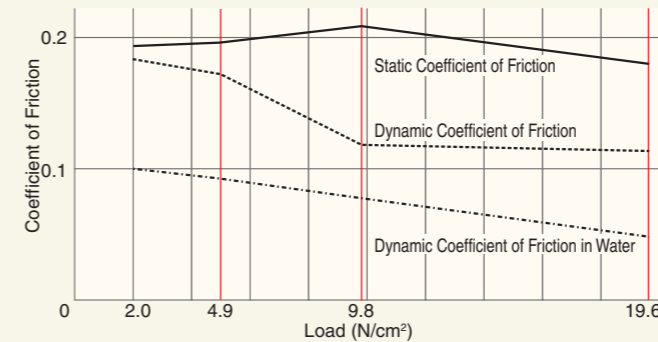

Specimen: UHMWPE
Testing apparatus: Coefficient of friction meter
Evaluation conditions: Sliding speed: 10mm/s; Material rubbed against: S45C steel (3S surface finish)

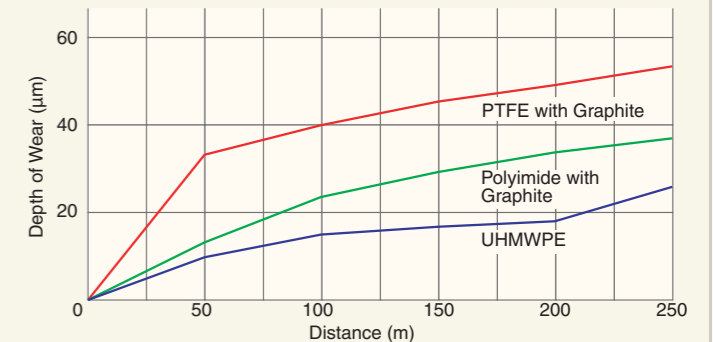

Specimen: UHMWPE, PTFE with graphite, polyimide with graphite
Testing apparatus: Universal wear tester
Evaluation conditions: Load: 4.4 N/cm²; Sliding speed: 0.104 m/s; Material rubbed against: 320-CW sandpaper
Distance for 1 pass back and forth: 50mm; Cycle: 125 cycles/min.

PO (Polyolefin) SPV®: Overview

PO SPV® is an environment-friendly surface protective material, which does not contain chlorine or plasticizer. The PO SPV® product line-up offers many variations suitable for all sorts of applications.

The following is the line-up of polyolefin SPV® products, which all use special polyolefin film for their base. The numerous variations of PO SPV® products are intended to meet various surface protection needs. Each product is made to be effective according to the nature of the surface protection, whether the surface is a metal sheet or plastic sheet, or whether the coated surfaces are to be protected during transportation or processing.

Product Group	Product No.	Thickness (mm)	Max. Width (mm)	Standard Length (m)	Color		
					White	Transparent	Blue (translucent)
M Series	M-6030	0.060	1,250	200	-	○	○
A Series	A-6050	0.065	1,250	100	-	○	○
C Series	C-6010	0.060	1,250	100	-	○	-
	C-100	0.060	1,250	200	-	○	-
	C-200	0.060	1,250	200	-	○	○
	C-300	0.060	1,250	200	-	○	○
	C-400	0.060	1,250	200	-	○	-
	C-500	0.060	1,250	200	-	○	-
V Series	C-600	0.090	1,250	200	-	○	-
	V-420	0.055	1,250	200	-	○	-
364 type	364CK2	0.050	1,250	100	-	○	-
	364MK2	0.055	1,250	200	-	○	-
	3641FK2	0.043	1,250	200	-	○	-
	3643FK2	0.045	1,250	200	-	○	-

Substrates: stainless steel BA plate, acrylic plate

- As small lot production may be required depending on the size and the color of the product, please consult our sales representative.
- The above chart shows example of measured values, not guaranteed values.



Surface Protective Materials

Protection Film for Interior Parts SPV®-C-600

Used for protection of automobile interior parts

SPV®-C-600 has been developed for protecting automobile interior parts, which are exposed to severe heat and UV radiation. This film can be perfectly applied to suit any specific location and surface size for protection, as well as effectively prevents scratching and keeps the vehicles from getting dirty during the assembly process.

Features

- Can be used for interior parts with a wide choice of substrates; no adhesive residue remains when peeled.
- Adheres well to rough surfaces.

Structure



Standard Size

Product No.	Thickness (mm)	Width (mm)	Length (m)	Color
C-600	0.090	1,250	200	Transparent

Applications

- General interior parts such as door trim, instrument panels and door steps



Tape for Wire Harnesses Low-VOC PVC Tape/Flame-retardant, heat-resistant and High heat-resistant PVC Adhesive Tape



PVC tape featuring Low-VOC, thin layer, heat-resistance and flame-retardant

This tape was developed to protect and bundle the wire harness (electric wire) which run all over automobiles. We are aiming to reduce vehicle's weight by making the tapes thinner as much as possible, and reducing the VOC level which also contributes to a better environment. Heat-resistant and flame-retardant tapes are also used in EV/HEV vehicle's wire harness.

Features

Low-VOC PVC Adhesive Tapes

- Flame-retardant tapes, heat-resistant tapes and other various products are available for many harnessing purposes.
- Environment-friendly tape of low VOC.
- General binding tape also has a thin layer type of 0.070mm thickness

Heat-resistance, flame-retardant and High heat-resistant PVC adhesive tape

- Flame-retardant tape also has a thin layer type of 0.070mm thickness
- Offers each temperature zone of heat-resistant type

Structure

Low-VOC PVC Adhesive Tapes

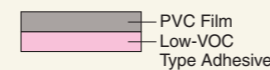

Applications

- For banding wire harnesses, identification and joint protection

Properties

Comparison of Base Properties

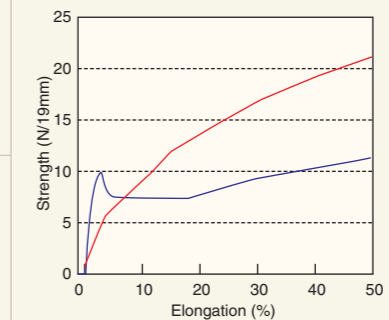

Comparison of the Characteristics of PVC Adhesive Tapes

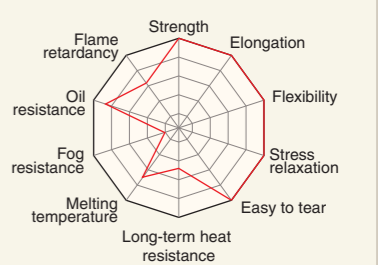

Low-VOC PVC Adhesive Tapes

Product	Product No.	Color	Thickness (mm)	Length (m)	Applications
General/bundling	No. 2101TVH/No. 2101NVH	Black	0.10	20	Low VOC emissions
General/bundling	No. 2117TVH/No. 2117NVH	Black	0.070	35	General unity thin layer type, Low VOC emission product
Color variation	No. 2107TVH/No. 2107NVH	Black, Blue, Green, Yellow, White, Brown, Gray, Red, Orange, Pink, Light green, Sky blue, Purple, Transparent	0.13	20	Low VOC emissions, color identification use
Flame-retardant	No. 2100FRTV	Black	0.11	25	Flame-retardant type
Flame-retardant	No. 2117FRTV	Dark gray	0.070	35	Flame-retardant thin type
Heat-resistant, flame-retardant	No. 2237FRTV	Orange, Gray	0.13	20	Heat-resistant, flame-retardant type
	No. 2239FRTV	Black	0.11	25	Fog-resistant, heat-resistant, flame-retardant type
High heat resistance	No. 2207TVH	Black (Please inquire for other colors)	0.13	20	Heat-resistance temperature limit: 85°C
	No. 2280TV		0.08	33	Heat-resistance temperature limit: 105°C
	No. 2290TV		0.11	33	Heat-resistance temperature limit: 125°C
Thicker	No. 213JTV	Black, Dark blue	0.30	10	Tube replacement use
Insulation & heat-resistant	No. 223S	Black, Blue, Green, Yellow, White, Gray, Red	0.190	20	Electronic insulation type

*Symbols at the end of the product names: TV=Made in Taiwan NV=Made in China

Acetate Cloth Adhesive Tape Series

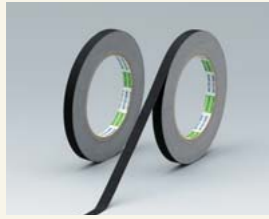

Acetate cloth adhesive tape offers superior heat resistance and flexibility.

Electrical insulation tape consists of acetate cloth coated with acrylic or rubber adhesive. These tapes are used for insulating electrical and electronic equipment, protective insulation of wire harnesses and binding.

Features

- Easy to work with good hand-cuttability
- Superior flexibility makes it ideal for binding uneven electrical wiring.
- Offers superior corrosion resistance.
- Environment-friendly tape of low VOC (No. 5EG, No. 153, No. 153N)
- High adhesion to backing and any adherend (No. 153, No. 153N)

Applications

- Outer insulation and termination of coils.
- For binding connection harness

Structure

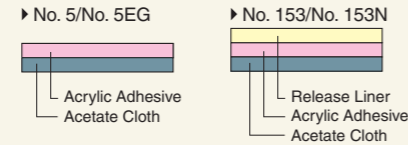

Properties

Product No.	Thickness (mm)	Standard Length (m)	Color	Peeling Force (N/19mm)	Tensile Strength (N/19mm)	Elongation (%)
No. 5	0.23	20/30/50	White/Black	5.0	120	20
No. 5EG	0.23	20/50	Black	6.0	120	20
No.153	0.21	50	White/Black	10.0	120	20
No.153N	0.21	50	White	8.0	100	20

Butyl Rubber Tape No. 11/No. 15



Long selling “waterproof insulation”

Butyl rubber tape No.11 is with liner and No.15 is without liner. These are waterproof insulation tapes and has excellent workability. You can wind this tape to the necessary thickness while elongating it by a factor of between approximately 2 to 2.5.

Features

- Self-fusing in a short time.
- Excellent electrical insulation properties.
- The main ingredient is butyl rubber, resulting in excellent waterproof performance.

Applications

- Insulation coating material for connection and terminal treatment of various electric cables.
- Coating of lead wire for electric instruments.



Structure

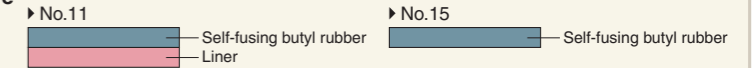

Properties

Item	Unit	Measured value
Thickness	mm	0.5
Width	mm	19
Length	m	10
Tensile strength (normal condition)	N/mm ²	3.1
Tensile strength (after heating)*1	N/mm ²	2.9
Elongation (normal condition)	%	550
Elongation (after heating)*1	%	570
Withstand voltage (10 kV × 1 minute)	-	OK
Dielectric breakdown voltage	kV/mm	44
Volumetric resistivity	Ω·cm	2 × 10 ¹⁷

*1 Heated for 96 hours at 100°C

Flame-retardant Acetate Cloth Adhesive Tape Series



Excellent flexibility and good hand-cuttability flame-retardant cloth acetate adhesive tape.

Flame-retardant electrical insulation tape consists of acetate cloth coated with acrylic or rubber adhesive. These tapes are used for insulating electrical and electronic equipment, protective insulation of wire harnesses and binding.

Features

- Easy to work with good hand-cuttability.
- Superior flexibility makes it deal for binding uneven electrical wiring.
- No.151UL is haloge free.
- No.151UL is high adhesion to backing and excellent flexibility compared to No.156A.

Applications

- For binding connection harness

Structure

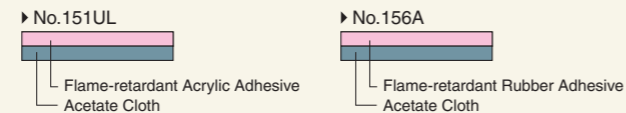

Properties

Product No.	Thickness (mm)	Standard length (m)	Color	Peeling Force (N/19mm)	Tensile Strength (N/19mm)	Elongation (%)
No.151UL	0.23	50	Black	5.0	120	20
No.156A	0.25	30	White/Black	8.0	130	21

No.151UL (UL 510 Flame Retardant E64170), No.156A (UL 510 Flame Retardant E34833)

Waterproof Insulation Sealing Material NF Series

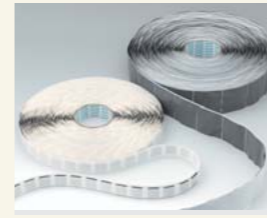

This material uses a non-halogen, flame retardant, lead-free compound in consideration of the environment.

We are expanding the applications of this sealing material to automobiles based on its record of achievement and reliability as an insulating material and filling and sealing material for branches, and other parts, of overhead power wires. Products that conform to various applications and methods of use are available.

Features

- Exhibits excellent adhesion to rough surfaces and electric wires (including non-halogen wires).
- Uses a non-halogen, flame-retardant compound and has low temperature to high temperature flexibility.
- PVC backing (NF-500PV) is lead-free in consideration of the environment.
- Does not droop at high temperature.
- Excellent electrical properties.

Structure

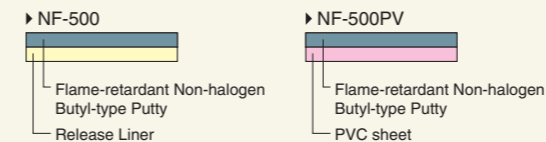

Properties

Item	Unit, test method	NF-500
Flame retardancy	15-second flame test	Self-extinguishment, No dripping matter
	Continuous 2-minute flame test	No dripping matter
Oxygen index	-	30
Adhesion	N/20mm	63.6
50% compression load*1	N/cm ²	11.5
Volumetric resistivity	Ω·cm	6.6 × 10 ¹⁴
Withstand voltage	5 kV 1 min.	No abnormality
Dielectric breakdown voltage	kV/mm	24
Droop test*2	1 mm max.	0
Hue	-	Black

*1 20 mm × 20 mm, compression ratio 5 mm/min.

*2 Drooping distance over 24 hours at 100°C

Super Clean Foam SCF® 100-200-400/P1500



Can handle microscopic clearances of 100µm. Thin layer, flexible and highly workable foam

SCF® is a highly flexible foam, which has a fine cell structure with a thinner and stronger layer than conventional foam, used for cushioning and dustproofing. A superior ability to follow contours enables SCF® to be used for clearances as small as 100µm. Its higher dustproofing reliability realizes more freedom of design. SCF® offers flexibility while facilitating work.

Features

- Superior compression and mounting properties enable foam to fit in tiny clearances.
- Superior ability to follow curves and uneven shapes enables the foam to be used for complicated designs.
- Enables fine width and thin layer processing, hence, the foam is applicable to complicated shapes.
- Easy to work with; can be used with no backup or thin backup.
- High impact absorption helps protecting LCDs.
- Clean; minimizes contamination to LCDs and other parts.

Applications

- Sealing materials for car navigator monitor frame
- Sealing materials for ETC receiver



Product Line-up

Product No.	Thickness (mm)	Color	Length (m)	Width (mm)
SCF100	0.5-1.0	Black	1-100	500
SCF200	0.5-1.5			
SCF400	0.3 / 0.4			
P1500	0.4-1.5			

*Tape thickness is available in 0.1mm. Double-coated adhesive tape is also available.
*P1500 is the next-generation, flame-proof model of P100UL and P200UL.

Properties

Product No.	Density (g/cm ³)	50% Compression Load (N/cm ²)	Tensile Strength (N/cm ²)	Extension (%)	Flame Retardancy
SCF100	0.045	1.4	1.00	210	-
SCF200	0.030	2.4	0.93	167	-
SCF400	0.045	1.4	1.09	141	-
P1500	0.070	4.6	0.70	60	UL94HF1 (Non-halogen)

Structure

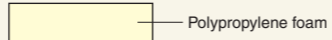

Semi-closed cell structure

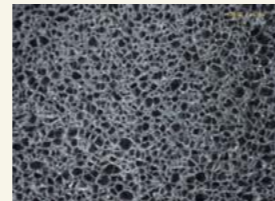

SCF®

Open cell structure

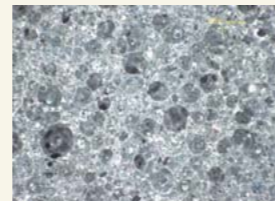

Other product (Urethane foam)

Flexibility

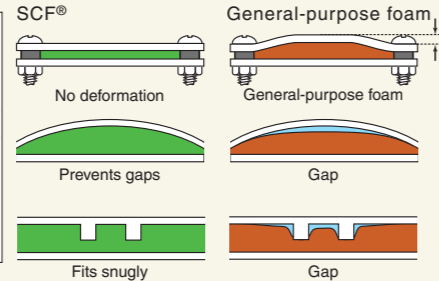
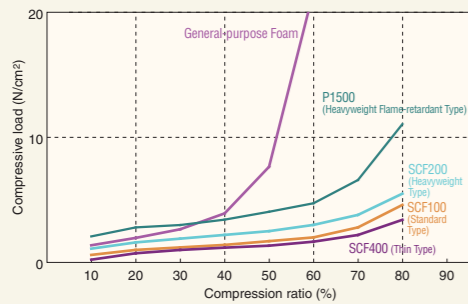

Note: Increasing compression rate could cause deformation of the frame.

Test method



Low VOC* Double-coated Adhesive Tape No. 512



Reduces the amount of VOC emissions.

No. 512 features a solvent-free acrylic adhesive and has less odor and VOC diffusion amount. No. 512 emphasizes "adhesion" and "easy handling" and adheres well to a wide range of substrates, including rubber foam and plastic materials. Awarded the 46th "Environmental Award" in Japan.

*VOC: Volatile Organic Compounds

Features

- Odor is drastically reduced compared to the existing line-up.
- VOC diffusion amounts are extremely small.
- Outstanding adhesion to PP, PE, etc.
- Tape is flexible and has superior adhesion to rough surfaces.
- Superior initial adhesion.

Structure

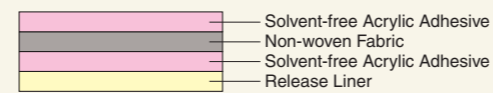

Standard Size

Thickness (mm)	Width (mm)	Length (m)
0.15	3-1,200	20/50

Applications

- Fixing various types of nameplates
- Fixing plastic displays
- General adhesion (adhesion of paper, film, etc.)



Fixing sound absorption materials around instrument panels



Fixing door trim and sound absorption materials



Fixing toner covers



Fixing floor mats

Properties

180° Peeling Force (by Temperature)

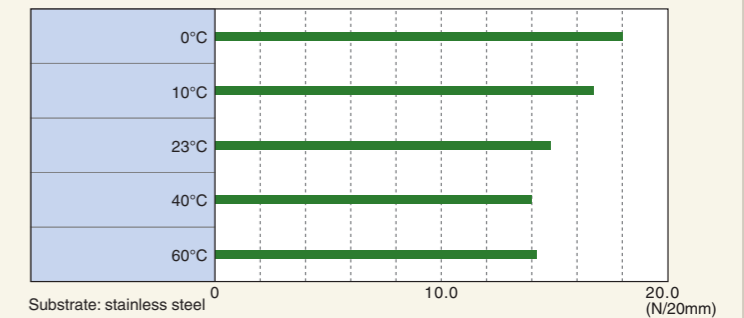

180° Peeling Force (by Substrate)

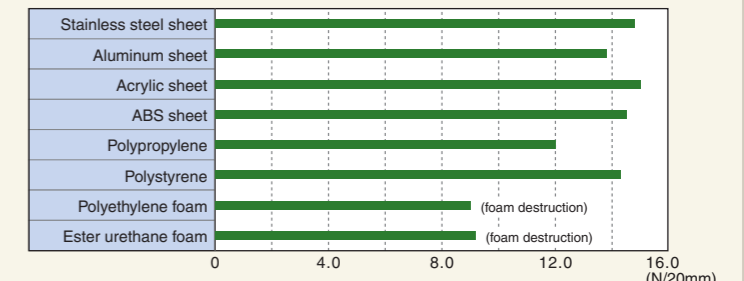

*Measured by peeling in a 180° direction at a speed of 300mm/min at 23°C with polyester film 0.025mm lining.

No. 512 Measurements of VOC Diffusion and Speed

Measured Substances	MHLW ² Guidelines (µg/m ³)	Densities (µg/m ³)	Diffusion Speed (µg/m ² ·h)
Formaldehyde	100	<5	<1
Acetaldehyde	48	<5	<1
Toluene	260	<5	<1
(o, m, p-) Xylene	870	<5	<1
Ethylbenzene	3800	<5	<1
Styrene	220	<5	<1
Tetradecan	330	<5	<1
Di (2- ethylhexyl) phthalate	120	<0.5	<0.2
Di-n-butyl phthalate	220	<0.5	<0.2

*1 Method of analysis: VOC analysis implemented by small-chamber method in compliance with JIS A 1901.

*2 The measured values of VOC diffusion, stated above, are less than the guideline values of the Ministry of Health, Labour and Welfare of Japan.

Removable Tape No. 5000NS



Flexible and strong nonwoven fabric carrier for easy removal

No. 5000NS is a double-coated adhesive tape, which consists of a strong and flexible nonwoven fabric carrier and powerful, pressure-sensitive adhesive. No. 5000NS can be adhered to various types of substrate, such as metal, plastic and urethane foam; at the same time, its superior tensile strength makes for easy removal without tearing. Nitto has resolved the problem of adhesive residue. Special adhesive is used for No. 5000NS, and this minimizes the residue of the adhesive when the tape is peeled off. All of these properties facilitate recycling; tape is removed easily for the parts to be disassembled, while adhesive residue is minimal and allows the parts to be reused.

Features

- Can be used for substrates to which it is usually difficult to apply tape, such as polyacetal and polypropylene.
- Non-woven fabric base offers excellent peeling properties; tape does not tear when peeled.
- Minimal adhesive residue when removed, even when it is removed after a long period of time.
- Can be used in a wide range of temperatures.

Structure

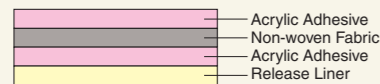

Standard Size

Carrier	Tape Thickness (mm)	Width (mm)	Length (m)
Non-woven Fabric	0.16	3-1,200	50

Applications

- Adhesion of PP and foam objects
- Fixing of various types of nameplates

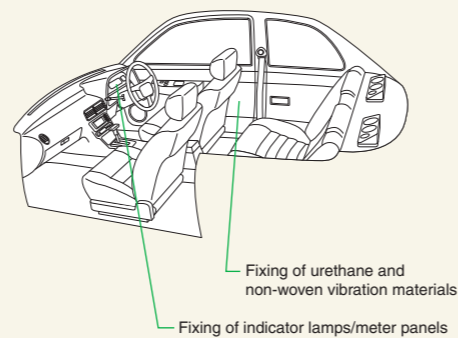

Properties

Tensile Strength

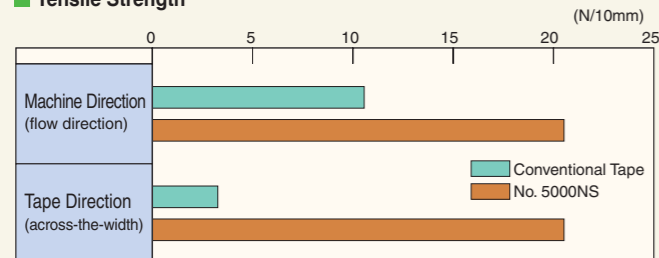

Test Method

Specimen size: 10mm (cut in machine direction and tape direction)
 Measurement temperature: Room temperature
 Peeling speed: 100mm/min.
 Distance between chunks of tensile tester: 50mm

180° Peeling Force (by Substrate)

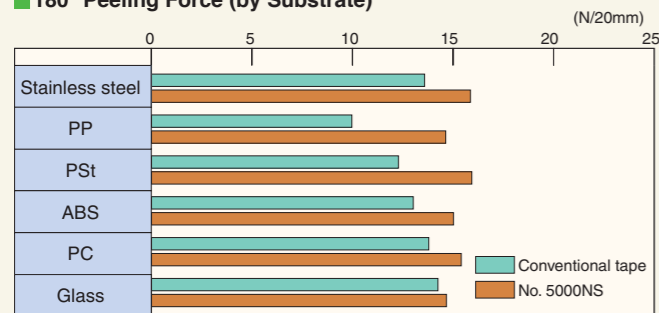

*Measured by peeling in a 180° direction at a speed of 300mm/min at 23°C with polyester film 0.025mm lining.

Example: Toner Cartridge Recycling

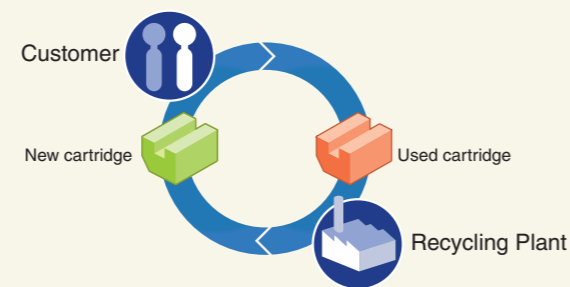

Disassembly

The tape is removed without tearing and leaves minimal adhesive residue, enabling effective parts disassembly. Facilitates recycling and can be reused either as processed or raw materials.

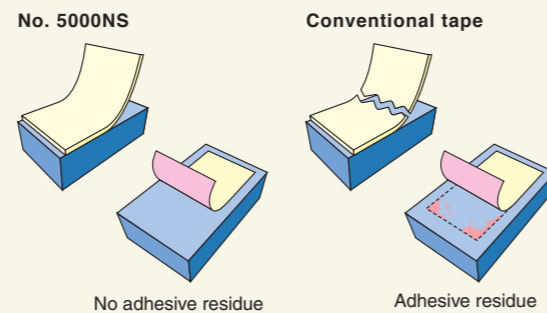

Double-coated Adhesive Tape for Oily Surface OW-5016



This environment-friendly low-VOC* adhesive tape also sticks well to oily surfaces.

This adhesive tape uses a solvent-free adhesive agent, resulting in low VOC emission levels. The 14 VOCs specified by the Ministry of Health, Labour and Welfare are not used in the adhesive tape as raw materials. This tape is suitable for fixing a wide variety of substrates such as metals, plastics, and foams. In addition, it has the potential to be used on oily surface. Awarded the 46th "Environmental Award" in Japan.

*VOC: Volatile Organic Compound

Features

- Excels in adherence to oily surface.
- Organic solvents are not present in the adhesive agents.

Structure

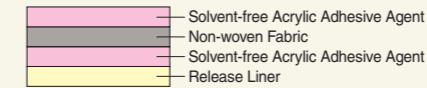

Standard Size

Tape Thickness (mm)	Width (mm)	Length (m)
0.16	3-1,050	20/50

Applications

- General seat frame
- Seat back frame
- Seat cushion

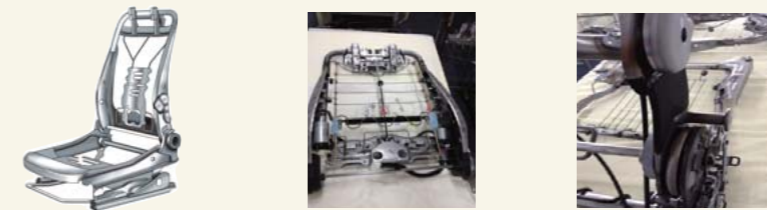

Properties

Adhesion to Many Different Oils

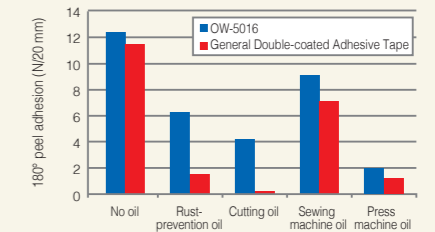

* Substrate: SUS304BA Oil spread: 5 g/m² Measurement: 30 minutes after bonding

180° Peel Adhesion-by Oil Surface and by Pressure Bonding Time

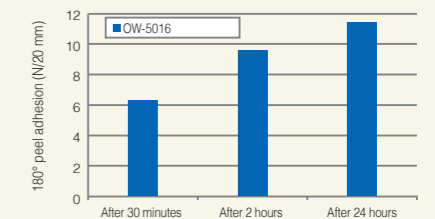

Low-VOC* Double-coated Adhesive Tape EW-514/EW-514D/EW-514DB



Environment-friendly and suitable to adhesive for rough surface

Double-coated adhesive tape exhibits minimum amount of VOC discharge level with the use of solvent-free acrylic adhesive. And superior repulsion resistance. Awarded the 46th "Environmental Award" in Japan.

*VOC: Volatile Organic Compound

Features

- Use no organic solvents (toluene, xylene, ethyl acetate, etc.)
- The guideline values for the 13 VOCs specified by Japan's Ministry of Health, Labour and Welfare are satisfied.
- Excellent adhesion to rough surface (foam, non-woven fabric, felt).
- EW-514D/EW-514DB are good performance for rough surface because of its thickness.

Structure

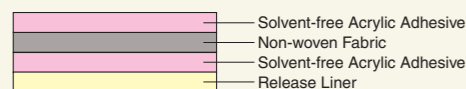

Applications

- Fixing of sound-absorption materials for automobile interior parts and home electrical appliances.
- Bonding of film and paper.
- Fixing of various plastics.

Standard Size

Product No.	Thickness (mm)	Width (mm)	Length (m)
EW-514	0.14	5-1,050	50
EW-514D EW-514DB	0.28	10-1,050	50

Properties

180° Peeling Force According to Type of Substrate

Product No.	Peeling Force (N/25mm)		
	Stainless	Ether Type Urethane Foam	Ester Type Urethane Foam
EW-514	12.0	2.8	11.0
EW-514D EW-514DB	14.0	9.0	16.0

*Measured by peeling in a 180° direction at a speed of 300mm/min at 23°C with 0.025mm PET lining.

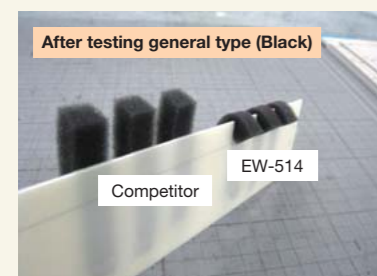

Repulsion Resistance (For Urethane Foam)

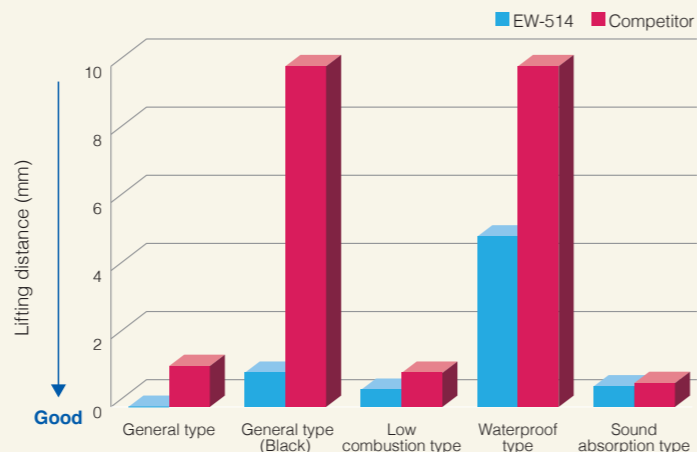

Test Measurement

Foam thickness: 10mm
 Foam or tape width: 10mm
 Fold length: 10mm
 Method of pressing: Foam and tape... Only self-weight
 Tape with foam and substrate (ABS)...
 2kg roller is applied in one back-and-forth motion
 Measure condition: 23°C/50%×24hrs.+70°C×2hrs later, measure lifting distance.

Heat-resistant Adhesive Tape (Usage Temperature Range: -60°C to +200°C)



NITOFロン®/Fluoroplastic Adhesive Tape No. 903UL

Applications

- Sliding noise abatement
- Heat-resistant electrical insulation

Standard Size

Product No.	Thickness (mm)	Maximum Width (mm)	Standard Length (m)	Color
No. 903UL	0.08/0.13/0.18/0.23	450	10	Gray

Structure

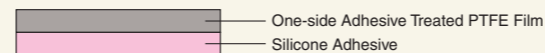

Properties

Product No.	Peeling Force (N/19mm)	Tensile Strength (N/19mm)	Breakdown Voltage (kV)	Elongation (%)
No. 903UL	7.1	93	11	220

Thickness: 0.13mm



NITOFロン®/Fluoroplastic Resin Impregnated Glass Cloth Adhesive Tape No. 973UL-S/973UL

Applications

- Heat-resistant fixing
- Smooth sliding

Standard Size

Product No.	Thickness (mm)	Length (m)	Color
No. 973UL-S	0.13	10	Beige
No. 973UL	0.15/ 0.18	10	Beige

Structure

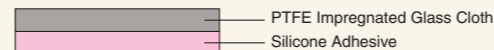

Properties

Product No.	Peeling Force (N/19mm)	Tensile Strength (N/19mm)
No. 973UL-S	6.8	240
No. 973UL*1	9.7	530

*1 Thickness: 0.18mm

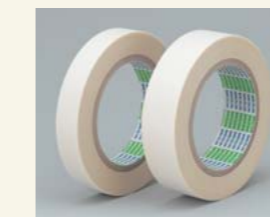

Glass-cloth adhesive tape serie No.188UL

Features

- Offers superior physical strength and electrical insulation properties.
- Offers superior thermal insulation.

Structure

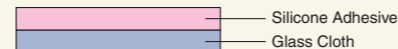

Standard Size and Properties

Product No.	Thickness (mm) Total (Backing)	Standard Length (m)	Color	Peeling Force (N/19mm)	Tensile Strength (N/19mm)	Elongation (%)	Breakdown Voltage (kV)	Electrolytic Corrosion Factor
No.188UL	0.180 (0.130)	33	White	6.7	600	5	3.5	0.96



Polyimide Adhesive Tape No. 360 Series

Applications

- Heat-resistant masking
- Heat-resistant electrical insulation

Standard Size

Product No.	Thickness (mm)		Length (m)	Color
	Backing	Total		
No. 360UL	0.025	0.060	20	Light amber brown
	0.050	0.090		
No. 360A	0.025	0.053	20	
	0.050	0.080		

Structure

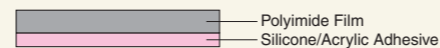

Properties

Product No.	Peeling Force (N/19mm)	Tensile Strength (N/19mm)	Elongation (%)	Breakdown Voltage (kV)	Electrolytic Corrosion Factor
No. 360UL	5.4	145	65	8.0	1.00
	5.4	250	65	11.0	
No. 360A	4.0	145	65	8.0	1.00
	4.4	250	65	11.0	

High Performance Vent Filter TEMISH®



Allows clean air to come in, but keeps out water and dust.

TEMISH® is PTFE (Polytetrafluoroethylene) porous membrane developed by Nitto. With hundreds of millions of micropores/cm², TEMISH® features water-resistance, dustproofing and air permeability. It also exhibits water, heat, chemical and weather resistance as well as exhibiting electrical properties, as excellent attributes of PTFE resin.

Structure

Water resistance

TEMISH® has a 0.1µm to 10µm porous membrane, therefore it has excellent water-resistance against 100µm to 300µm of water droplets/rain.

Air permeability

TEMISH® allows 0.0004µm of water vapor to pass through 0.1µm to 10µm of porous membrane.

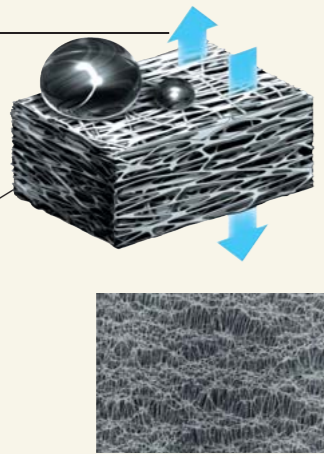

Function

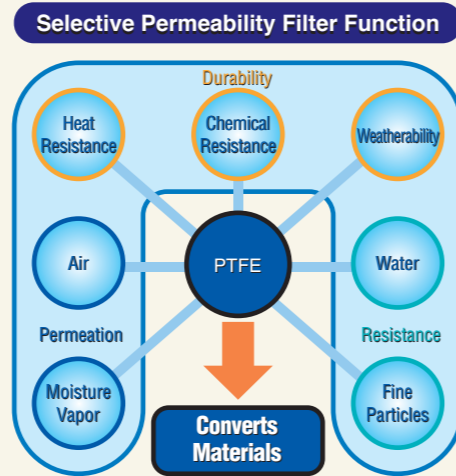

Evaluation Methods for TEMISH®

Air Permeability Test (Gurley Method) [JIS L 1096]

Measurement area: 642mm²
Measurement air volume: 100ml
Measurement pressure: 1.23kPa

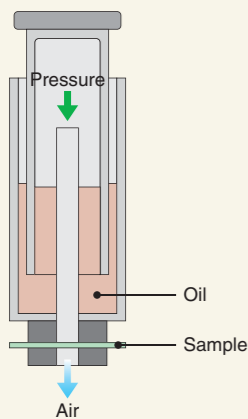

Air Permeability Test (Frazier Method) [JIS L 1096]

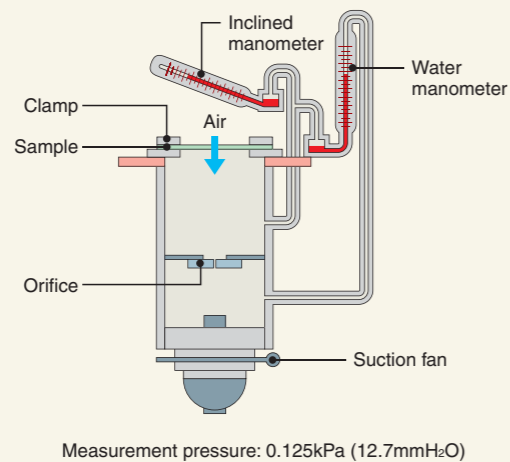

Water Resistance Test [JIS L 1092]

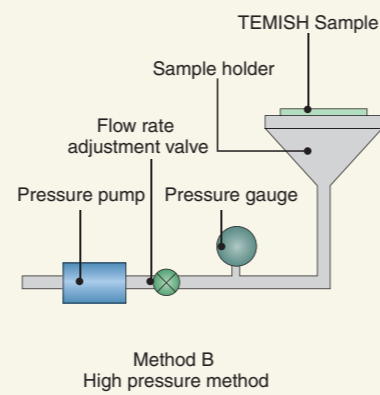

Applications

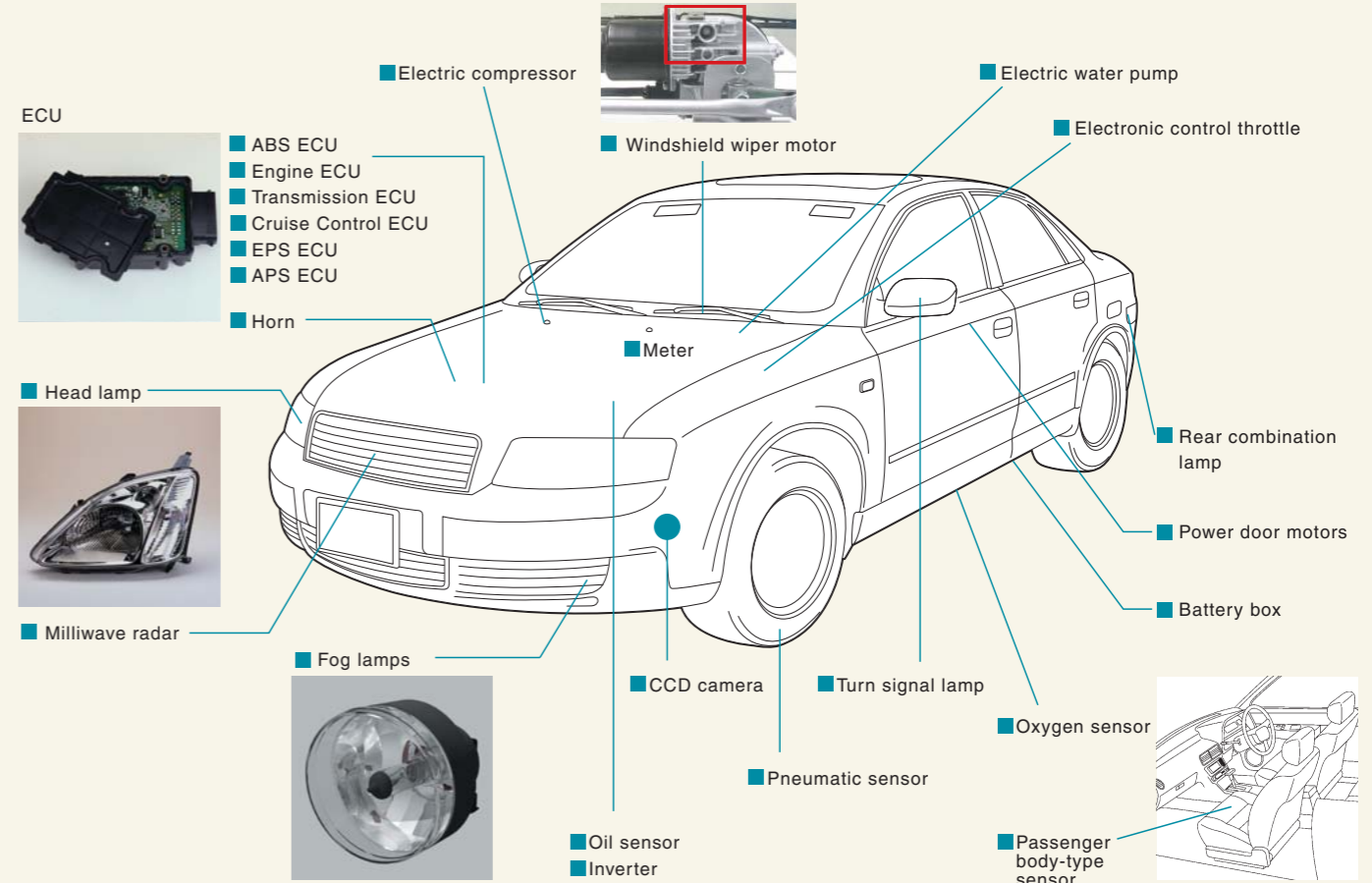

Product Line-up (Patch Type)

Type	Backing Materials	Product No.	Thickness (mm)	Air Permeability ^{*1}		Water Resistance ^{*2} (kPa)	Applications
				Gurley (sec)	Frazier (cm ³ /cm ² ·sec)		
Two-layered product Hydrophobic type	PET net	S-NTF1026-N06	0.10	10	-	200	High water resistance
		S-NTF1033-N06	0.10	(0.3)	5	7 ^{*3}	High air permeability
Two-layered product Oleophobic type	PET woven fabric	S-NTF1026-C02	0.13	10	-	200	High water resistance
	Printed PET non-woven fabric	S-NTF2026A-N06	0.10	10	-	200	Oleophobic, high water resistance
		S-NTF2131A-PS06	0.20	12	-	100	Oleophobic, high water resistance, high strength, high heat resistance
	PET non-woven fabric	S-NTF2122A-S06	0.20	35	-	250	Oleophobic, high strength, high heat resistance
S-NTF2131A-S06		0.20	12	-	100		
Single-layered product Oleophobic type	-	S-NTF2133A-S06	0.20	4	-	30	Oleophobic, high water resistance, no difference between front and back sides, Ultra high heat resistance
		S-NTF820A	0.30	12	-	100	

*1 Gurley testing method, Frazier testing method *2 B Method (high water pressure) *3 A Method (Low water pressure)

Features of Oleophobic TEMISH®

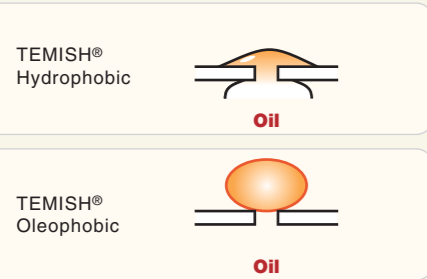

Test Fluid	25°C		
	5 min.	48 hrs.	96 hrs.
Engine oil	○	○	○
Long life coolant	○	○	○
Battery fluid	○	○	○
Washer fluid	○	○	○
Neutral detergent	○	○	○
Brake fluid	○	○	○
Grease	○	○	○
Saturated calcium chloride solution	○	○	○

[Test method]
Drop-test liquid on TEMISH® PTFE porous membrane and check if the liquid penetrates at room temperature (25°C).
○ indicates that the liquid did not penetrate. × indicates that the liquid did penetrate.

Patch Type

Composition of Product

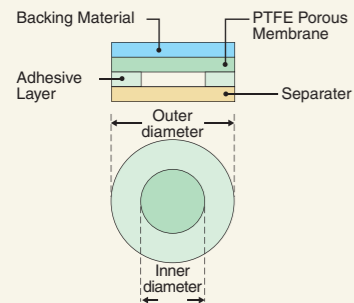

Sheet

Outer diameter	Sample size (mm)														
	4.8	5.6	7	10	11	12	14	16	18	20	23.5	25	30	35	40
Inner diameter	2.3	3	4	6	—	5	8	10	12	15	17.5	20	25	30	35

Reel

Outer diameter	Sample size (mm)							* General processing tolerance ±0.2mm * Please consult our sales representative for other available sizes.	
	7	8	12	13.8	14	15	16		16
Inner diameter	4	4	5	6	6	7	10	12	18

Sheet

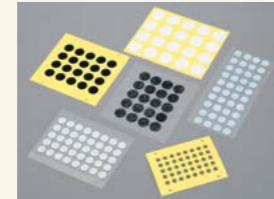

Reel

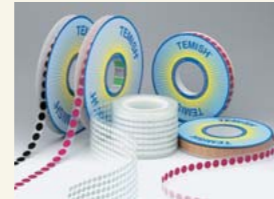

Explanation of Product No.

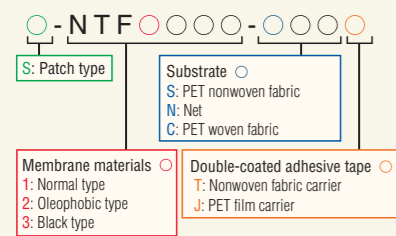

Precautions for handling and processing TEMISH®

- Do not damage surface.
- Do not load on the membrane package.
- Do not use pointed tweezers to pick up the membrane.
- Do not apply undue tension or pressure on the product or expose to excessive heat, friction or ultrasonic waves.
- Remove static electricity from the membrane because it charges easily and may be damaged by the charge.
- Avoid dust and attaching packaging paper when storing.
- Store indoors at room temperature, away from direct sunlight.
- Avoid oil, soap and oils from skin from touching the product.
- Do not burn fluoroplastic products.
- Poisonous gas is produced if processed product chips or used product is burned. Please dispose of it in a landfill.

TEMISH® VPF Series

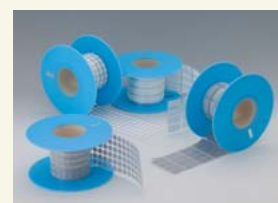

Features

- The filter design is specific for automotive lamps to quickly discharge pressure and moisture in the lamp.
- Excellent properties such as waterproofing, dust-proofing, and oil-repellent.

Mass production (reel form only)

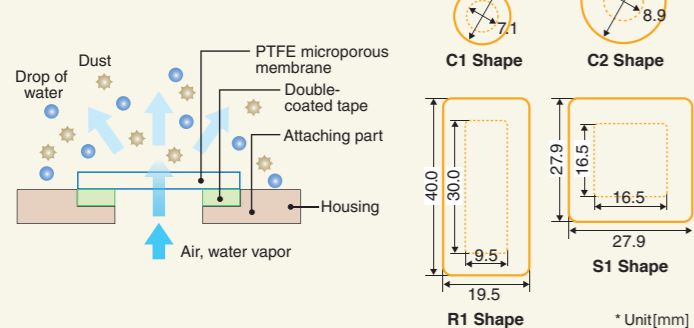

Product No.	Features	Typical applications	Air permeability*1 (cm ³ /min)		Water entry pressure*2 (kPa)	
			Typical value	Minimum value	Typical value	Minimum value
VPF110A2-R1	PTFE Single-layered product	LED Head Lamp / Rear Lamp	215	> 105	100	> 70
VPF110A2-S1			205	> 100	100	> 70
VPF110A2-C1		LED Rear Lamp / Fog Lamp	30	> 15	100	> 70
VPF110A2-C2	45		> 24	100	> 70	
VPF310A2-R1	High ventilation three-layers product	LED Head Lamp / Rear Lamp	2200	> 860	50	> 15
VPF310A2-S1			2100	> 825	50	> 15
VPF310A2-C1		LED Rear Lamp	300	> 130	50	> 15
VPF310A2-C2			470	> 190	50	> 15

*1 Permeation volume at differential pressure 1kPa
*2 JIS L 1092 B method (high water pressure method)
* This data is a representing value, not guaranteed performance.
* It is a special product for the automotive lamp vent filter applications. Please refrain from using it for other uses.

TEMISH® Composite Parts

- New functions have been exhibited by compounding TEMISH® with molded objects, such as plastic and rubber, and making components. Compounded parts realize total cost reduction by reducing the numbers of components and man hours for mounting.

TEMISH® CAPSEAL™

Structure

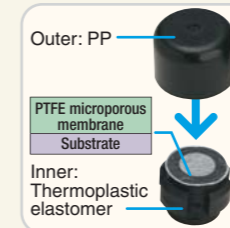

Functions of Cap Seal

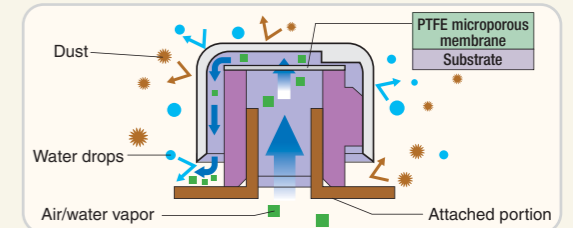

Features

- As cap seal has been made into a component, it enables one-step attaching, and reduces total costs.
- Offers superior mechanical strengthening and is easy to use.
- The filter is protected by a cap and thus prevents direct damage to the membrane surface.

Product No.	Features	Main Applications	Color (outer)	Air Permeability (cm ³ /min)	Water Resistance (kPa)
C2-NTF1026-L01	High water resistance	Fog lamps, rear lamps	Black	50*1	100*3
C2-NTF9208-L01	High air permeability	Head lamps, rear lamps	Gray	1,500*1	20*3
C2-NTF130SL	High air permeability	Head lamps	Brown	13,000*1	3*2
C2-NTF210SL	Oleophobic, high water resistance	Fog lamps	Blue	50*1	100*3
C2-NTF220SL	Oleophobic, high air permeability	Head lamps, rear lamps	Green	1,500*1	20*3

*1 Volume of air permeability when the differential pressure is 1kPa. *2 JIS L 1092 A method (low water pressure method)
*3 JIS L 1092 B method (high water pressure method)

TEMISH® Z Series

Structure

Z3-NTF210SE



Z-PLUG-S



Cross Section

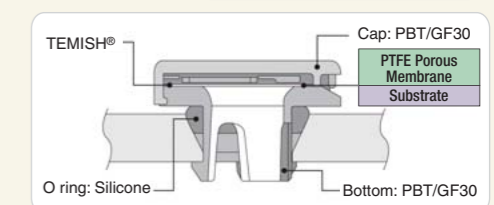
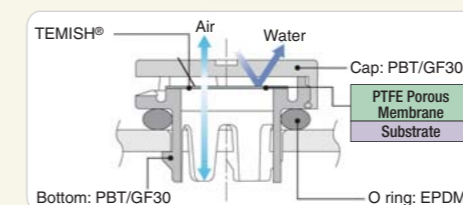

Features

- Has excellent oil repellency and restricts various types of automobile-related oils.
- Has superior durability and is suitable for internal pressure adjustment materials for automobile ECU.
- Enables one-step attachment in the desired direction.
- High-heat and low-temperature resistance. (-40°C to 125°C)

Product No.	Features	Main Applications	Color (outer)	Air Permeability (cm ³ /min)	Water Resistance (kPa)
Z3-NTF210SE	Oleophobic · high water resistance	ECU, Battery pack	Black	130*1	210*2
Z-PLUG-S				260*1	100*2
ZH-PLUG-S				260*1	100*2

*1 Volume of air permeability when the differential pressure is 1kPa. *2 JIS L 1092 B method (high water pressure method)

TEMISH® E3-NTF Series

Structure

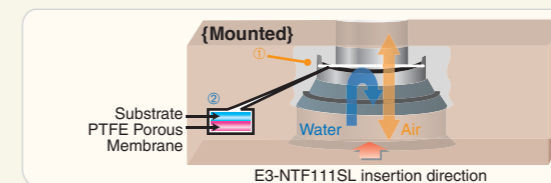

Features

- Can be mounted in "one-touch". (Recommended to mount with non-woven fabric side [black] up.)
- Excellent air permeability, water resistance, and dustproofing properties.

Features

Product No.	Features	Main Applications	Color (outer)	Air Permeability (cm ³ /min)	Water Resistance (kPa)
E3-NTF111SL	High water resistance	Motor	Black	23*1	100*2
E3-NTF211SL	Oleophobic	Motor	Black	20*1	100*2

*1 Volume of air permeability when the differential pressure is 1kPa. *2 JIS L 1092 B method (high water pressure method)

HT Sheet with High Thermal Conductivity

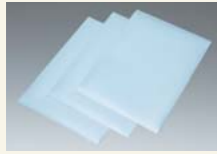

The HT series with high thermal conductivity is utilized in various fields, including in-vehicle components centered on digital electrical appliances. Thin film formation will be utilized as a tape manufacturer to address customer needs based on the heat radiation and insulation design that is accumulated from aluminum-based heat-radiating substrate.

HT Series·HT-HL Series

Extra soft thermal-conductive sheet with the matrix resin of silicone gel

Structure

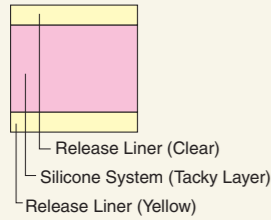

Functions

Test Item	Unit	Test Method	HT-150	HT-200	HT-250	HT-300	HT-100HL	HT-200HL	HT-300HL
Thickness	mm	Dial gauge	1.5±0.2	2.0±0.2	2.5±0.3	3.0±0.3	1.0±0.1	2.0±0.2	3.0±0.3
Specific gravity	-	ASTM D792	2.5			3.0			
Tacky side	-	-	Exist						
Hardness	-	Asker C	20			35			
Tensile strength	MPa	ASTM D412	0.3			0.5			
Electric strength	kV	ASTM D149	16.0	19.0	21.0	24.0	11.0	16.0	21.0
Breakdown voltage	kV	ASTM D149	21.0	24.0	27.0	30.0	18.0	23.0	28.0
Thermal conductivity	W/mK	ASTM E1530	1.0			2.5			
Thermal resistance	m ² K/W	ASTM E1530	1.5x10 ⁻³	2.0x10 ⁻³	2.5x10 ⁻³	3.0x10 ⁻³	0.4x10 ⁻³	0.8x10 ⁻³	1.2x10 ⁻³
Flame retardancy	-	UL94	V-1			V-0			

HTR Series

Ultra thin thermal-conductive sheet with the matrix resin of silicone rubber

Structure

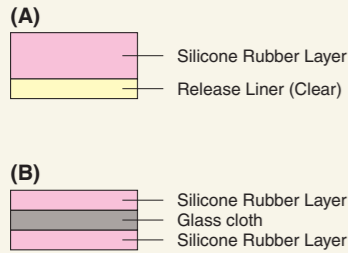

Functions

Test Item	Unit	Test Method	HTR-025 (G)
Constitution	-	-	B
Color	-	-	Light blue
Substrate	-	-	Glass cloth
Thickness	mm	Dial gauge	0.25±0.05
Specific gravity	-	ASTM D2240	2.4
Tacky side	-	-	-
Hardness	-	Asker C	90
Tensile strength	MPa	ASTM D412	34.3
Elongation	kV/1min	ASTM D412	2
Breakdown voltage	kV	ASTM D149	6.6
Thermal conductivity	W/mk	ASTM E1530	0.8
Thermal resistance	m ² K/W	ASTM E1530	0.23x10 ⁻³
Flame retardancy	-	UL94	V-1

Application

Between MPU, package and heatsink, cooleruni

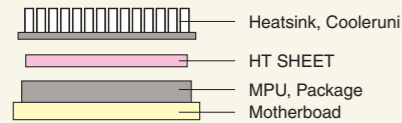

Between MPU, package and metal, housing

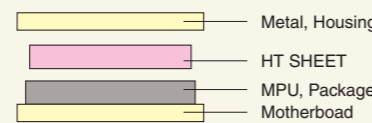

Notes

- Wipe off the oil, moisture and dust thoroughly on the surface on the adherend such as the heat sink, cooler unit, metal chassis, MPU and the package.
- To adhere well, press the adhesive hard against the adherend.
- Store this product in a cool dark place out of direct sunlight.
- Before use, make sure that the specifications of this product are suitable for the application.

Heat-resistant Moisture Proof Coating Material for PCB ELEM COAT LSS Series



In addition to the fundamental features of flexibility, low moisture permeability, and hydrolysis resistance, the new moisture proof coating material offers the following features:

- 1) Heat resistance
 - 2) Use of solvents that conform to the PRTR and the Export Trade Control Order
- This new heat-resistant moisture proof coating product contributes to environmental load reduction.

Features

- Does not include solvents prohibited by PRTRs and overseas shipping regulations, reducing environmental loads.
- Low Young's modulus and coefficient of thermal expansion means the material is not affected by temperature changes, so there is no stress on boards or chips.
- Forms film only 5-10 minutes after coating. Also, uses a polymer consisting of a modified rubber-based material as its primary ingredient, so the film is resilient and resists the development of cracks.
- LSS-520MHF enables black-light smear tests to be performed. We have the diluted product which can be coated by curtain coating without dilution by customer. (K type)
- LES-540E is VOC-free.

General Properties

Item	Unit	LSS-520MH	LSS-520MHB	LSS-520MHF	LSS-520MHB-K	LSS-520MHF-K	LSS-540E	Measuring Condition
Solid content	%	25	25	25	15	15	40	—
Viscosity	mPa · s	400	400	400	40	40	12	ASTM D-1084
Color	—	Clear	Blue	Fluorescence	Blue	Fluorescence	Fluorescence	—
Young's modulus	MPa	75	75	75	75	75	9.2	Tensile speed: 10mm/min.
Elongation	%	460	460	460	460	460	500	Tensile speed: 300mm/min.
Moisture permeability	g / cm ² · day	0.002	0.002	0.002	0.002	0.002	0.0035	40°C X 90% Thickness: 100µm
Set time to touch	Min.	5	5	5	5	5	15	Thickness: 30µm
Thermal resistance	125°C	>5000	>5000	>5000	>5000	>5000	>2000	Time until elongation ratio reduce by half
	135°C	>3000	>3000	>3000	>3000	>3000	>2000	
	150°C	1200	1200	1200	1200	1200	>2000	

* The above chart shows example of measured values, not guaranteed values.

Insulating Paper NPN/STRATA Series



Realization of multilayered structure by bonding multi-functional adhesive and by ad-hoc material selection

Providing insulating paper with excellent insulation, heat resistance, durability and mechanical strength for eco-car motor

Features

- Insulation
 - Ordinary temperature: 40°Cx90% RH24Hr
 - The distilled water soaking of 25°C in 24 hours: It preserves the insulation properties and breakdown voltage of the ordinary temperature
- Heat resistance
 - IEC international standards
 - Tensile strength F class (155°C)
 - Dielectric breakdown strength H class (180°C)
- Durability
 - Reliability and endurance based on the arrhenius plot and on the motor-let test
- Mechanical strength
 - Support for the automation of the motor manufacturing process
 - Insert performance in stator-slot
 - Strength properties are not bucked

Application

- Example of use in the motor
 - Slot paper
 - Wedge paper
 - Phase paper



Properties

Product No.	Thickness (mm)	Tensile Strength (MD) MPa	Tensile Strength (TD) MPa	Dielectric Breakdown Voltage (kV)
NPN-222(SA)	0.21	90	65	14
NPN-252(SA)	0.29	105	100	20
STRATA3-200T1	0.20	66	53	15

STRATA is a non-solvent three-layer insulating paper, which uses no adhesive. Aramid-paper, the surface material of STRATA, has distinctively improved hydrolytic capability and thermal conductivity. STRATA is a completely new insulating paper superior in these properties, compared with a conventional one.

Nitto Group Technical Support Centers

Product Information Contacts

- About Products
- Catalog and Data Sheet Delivery
- Various Available Product Samples
- Practical Evaluations
- Other

Double-coated adhesive tapes

TCAT Tape Customer Assistant Team

Support Products: Double-coated adhesive tape, Metal foil tape
Supported Sample Sizes: A4, specified width (small roll)
TEL: +81-532-41-8400/ +81-532-41-8267 FAX: +81-532-41-8473
E-mail: tcat@nitto.co.jp



Foam sealing materials and others

TFOX Tape and Foam Expert Support Center

Support Products: Foam materials, Waterproof and airtight tapes, Masking tapes, Vinyl tapes, Safety related materials, Anti corrosion materials, Bar code labels.
TEL: +81-532-41-7838 FAX: +81-532-41-8446
E-mail: tfox@nitto.co.jp



Surface protective materials

TDOC Technical Dock (Doctor)

Support Products: Surface protective films, Masking tape for plating
Supported Sample Sizes: Specified width (small roll, approx. 20m)
TEL: +81-532-41-7223 FAX: +81-532-41-8446
E-mail: tdoc@nitto.co.jp



Tapes for electrical & electronic equipment

TCOW Technical Support for Customer of World

Supported Products: Electrical insulating tapes, Tapes for transporting and manufacturing electronic components, Semiconductor wafer protection and fixing tapes
TEL: +81-532-41-7559 FAX: +81-532-41-8446
E-mail: tcow@nitto.co.jp



Hours: 9:00 - 17:30 (excluding Saturdays, Sundays, public holidays, year-end and new-year period and summer holidays)
18, Hirayama, Nakahara-cho, Toyohashi, Aichi 441-3194

Engineering plastic products and others

EYES Engineering Plastics Your Enhancement System

Support Products: Fluoroplastic products (sheets, tapes, filters), Ultra-high molecular weight polyethylene products (Low-friction tape, Air permeability sheets)
Supported Sample Sizes: A4, etc.
TEL: +81-48-571-3340 FAX: +81-48-571-3325
E-mail: eyes@nitto.co.jp



Hours: 9:00 - 17:30 (excluding Saturdays, Sundays, public holidays, year-end and new-year period and summer holidays)
1-8-5, Hatara-cho, Fukaya, Saitama 366-8521

NITTO SHINKO products

NITTO SHINKO CORPORATION CUSTOMER CENTER

TEL: +81-776-67-0700 FAX: +81-776-67-8090
E-mail: tsc-nsk@nitto.co.jp



Hours: 9:00 - 17:00 (excluding Saturdays, Sundays, public holidays, year-end and new-year period and summer holidays)
110-1-1, Maruokacho Funayose, Sakai-shi, Fukui, 910-0381

- The contents of this catalogue are effective as of October 2020.
- Certain products listed in this catalogue may not be available in some countries. Please contact us via our website for product availability.
- The information contained in this catalogue is subject to change without prior notice. This can be for, but not limited to, product improvement or other reasons at our own discretion.
- The data and figures contained in this material are NOT guaranteed values but typical values.
- The application examples of products stated in this catalogue are for illustrative purposes only and NOT guaranteed. Please

- read all instructions completely before use.
- All text and images in this catalogue are copyrights of Nitto Denko Corporation.
- All logos, product names, and other related information used in this catalogue are the brands or registered trademarks of Nitto Denko Corporation and its affiliates in Japan and/or other countries.
- If you wish to use the content of this catalogue for purposes other than the original intent, please consult us in advance. Any unauthorized use, copying or reprinting of the contents or part thereof in this catalogue without obtaining our prior written consent is strictly prohibited.